Ultrasonic sensors XX range

Catalogue



Simply easy!™



Optimise detection with XX range

Detect objects in challenging applications with our XX ultrasonic sensors range. These ultrasonic sensors offer an efficient solution for reliable and high performance detection at distances of up to 8m, on window mode.

* The window mode enables suppression of the foreground and the background using the same sensor.

> A technology suited to your needs

Detect objects regardless lighting conditions or material reflectivity degree

> 3 operating modes for efficient detection

Ideal for detecting irregular-shaped objects

> Short or long distance detection

From 50 mm upto 8m

Contents

Customer benefits	pages 2 and 3
Selection guide based on application	pages 4 and 5
Product selection guide	pages 6 and 7
Product applications	pages 10 and 15
Ultrasonic sensors XX range	
General	pages 16 to 21
Cylindrical sensors	
M12 sensors (digital sensors - Diffuse, Thru-beam)	
M18 sensors (digital sensors less than 0.5m- all Diffuse)	pages 22 to 26
M18 sensors (digital (Diffuse) & analog sensors - 0.5 m)	pages 27 to 30
Thru-beam (digital sensors 61 cm & 1m)	pages 27 to 30
M18 sensors (digital & analog sensors - 1m)	pages 31 to 36
M30 sensors (digital & analog sensors - 1m, 2m, 8m)	pages 37 to 40
Application - Sensors for monitoring 2 levels	pages 41 to 43
XX range, general purpose Ø 30 mm	pages 51 to 69
Flat format sensors	
Diffuse, Reflex, Thru-beam system	pages 44 to 50
XX configuration software	pages 70 to 72
Accessories	pages 73 to 75
Product reference index	page 76

> A technology suited to your needs

Ultrasonic sensors enable non-contact detection of objects in many kinds of industrial environment, irrespective of :

- material (metal, plastic, wood, cardboard, etc.),
- nature (solid, liquid, powder, paste, etc.),
- colour,
- degree of transparency.

The ultrasonic sensors are simple to install; they feature integrated connectors, or cable versions in select models, and offer a wide range of cabling and mounting accessories for a seamless integration.

> 3 operating modes for efficient detection

Diffuse mode

An object reflects the ultrasonic wave back to the sensor which, in turn, changes the output state.

This operating mode is well suited for detecting objects with flat surfaces that are positioned perpendicularly to the direction of the ultrasonic beam.

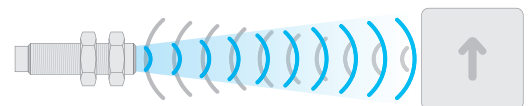

Reflex mode

The sensor is permanently detecting a fixed background (previously taught) on a machine or application. When another object breaks the ultrasonic beam, the output changes its state.

Well suited for detecting objects that absorb the ultrasonic waves (sponges, etc.) or that do not reflect the wave back to the sensor (non-flat surfaces, pointy or irregular-shaped objects).

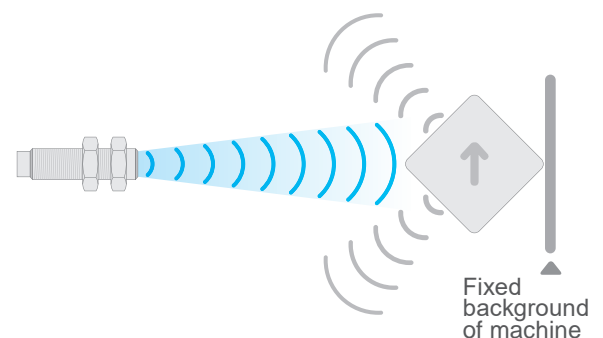

Thru-beam mode

The transmitter is constantly sending an ultrasonic wave to the receiver. When an object breaks the ultrasonic beam, the output changes its state.

Well suited for small object detection and applications where higher accuracy and faster response time are required.

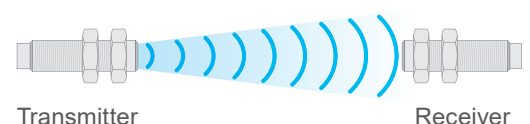

> Long distance proximity detection

Ultrasonic technology allows now for long distance proximity detection. The XXV Ø18 ultrasonic sensors enable detection from 0 to 50 mm (i.e. 2.5 times farther than standard inductive proximity sensors) with minimal environment constraints or object material and colour restrictions.

Sensors mounted too close to moving-metal parts are exposed to hits or impacts which can cause machine downtime. Being able to install sensors farther away from moving targets reduces the exposure to potential incidents. You increase installation profitability!

x 2,5
detection distance
than standard
inductive proximity
sensors

XXV Ø18

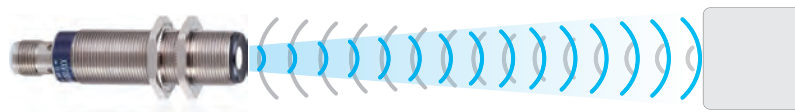

Standard inductive proximity sensor

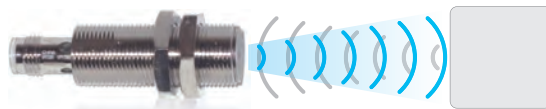

The XXV ultrasonic sensor is a “Plug and Play” solution with no adjustment or teaching required. Its solid-state output changes state when an object is less than 50 mm away from the sensor face.

Its accurate and well-defined transmission angle enables precise detection. Crosstalk with other sensors and object edge effects are mastered.

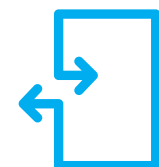

Plug & Play solution



100%
Worldwide availability

> Selection guide based on application

Type of detection

Detection "Digital"

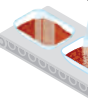
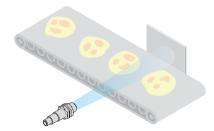
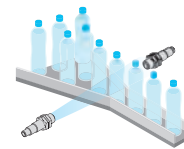
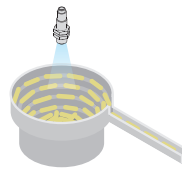

Assembly

Conveying

Pack

Machine part

Vibrating bowl

Presence
Absence

Transparent
bottles

Jam

Flow

Tran

Sensor type

Ø18
(M18x1)



Ø12
(M12x1)



Ø18
(M18x1)



Ø30
(M30x1,5)



7,6x19x33



16x30x74



18x33x60
Ø18
(M18x1)



80X80X34



 Diffuse mode



 Reflex mode

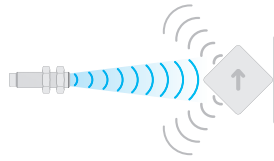

 Thru-beam mode



	Regulation "Analogue output"					Level monitoring	Mobile Equipment
--	------------------------------	--	--	--	--	------------------	------------------

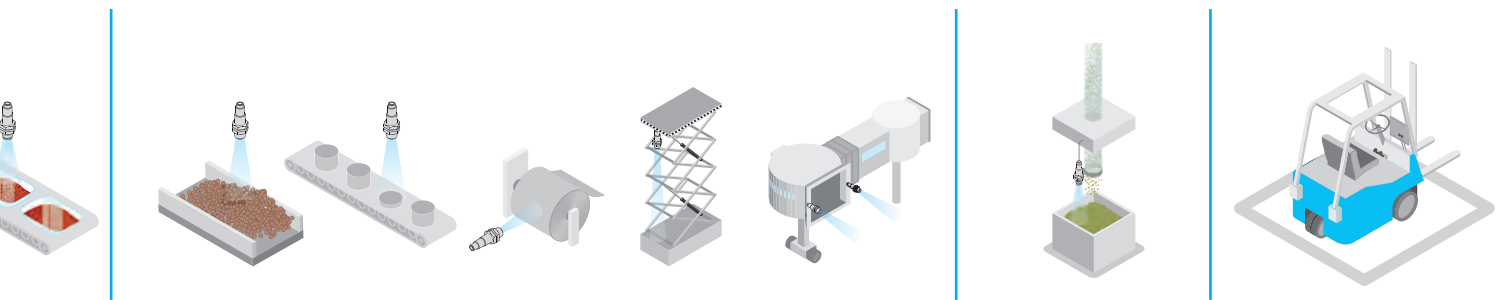

Packaging	Conveying		Packaging	Handling	Handling	Process	Forklift
-----------	-----------	--	-----------	----------	----------	---------	----------

Transparent film	Material level	Height of part	Radius of strip roll	Height of elevating table	Aircraft boarding bridge	Monitoring 2 thresholds	Filling Emptying	Filling Emptying
------------------	----------------	----------------	----------------------	---------------------------	--------------------------	-------------------------	------------------	------------------

<input type="checkbox"/>	<input type="checkbox"/>					<input type="checkbox"/>	<input type="checkbox"/>
<input type="checkbox"/>	<input type="checkbox"/>					<input type="checkbox"/>	<input type="checkbox"/>
<input checked="" type="checkbox"/>	<input checked="" type="checkbox"/>				<input type="checkbox"/>	<input checked="" type="checkbox"/>	<input type="checkbox"/>
<input checked="" type="checkbox"/>	<input checked="" type="checkbox"/>					<input checked="" type="checkbox"/>	<input type="checkbox"/>
<input checked="" type="checkbox"/>	<input type="checkbox"/>					<input type="checkbox"/>	<input type="checkbox"/>
<input checked="" type="checkbox"/>	<input type="checkbox"/>					<input type="checkbox"/>	<input type="checkbox"/>
<input checked="" type="checkbox"/>	<input checked="" type="checkbox"/>				<input type="checkbox"/>	<input type="checkbox"/>	<input type="checkbox"/>
<input type="checkbox"/>	<input checked="" type="checkbox"/>			<input checked="" type="checkbox"/>		<input type="checkbox"/>	<input type="checkbox"/>

Ultrasonic sensors

XX range
Cylindrical type

Applications
Non-contact detection of sound reflecting objects regardless their shape, material, colour, orientation, etc.

Dimensions (mm)

Sensors with solid-state digital output

Cylindrical type



Sensing distance Sn	Diffuse
	Reflex
	Thru-beam
Assured operating distance (mm)	
Power supply	
Type of output	
Function	
Degree of protection	
Connection	
Sensor type	
Page	

5 cm	10 cm	–	5 cm	15 cm	50 cm
–	–	–	–	–	50 cm
–	–	20 cm	–	–	–
6.4...51 fixed	6.4...102 fixed	–	2...50 fixed	25...152 fixed	Adjustable using teach mode
12...24 V $\overline{\text{---}}$ with protection against reverse polarity					
PNP/NPN	NPN or PNP	PNP/NPN	PNP or NPN	PNP/NPN	NPN or PNP
NO	NO	NO/NC	NO NC	NO	NO
IP 67	IP 67	IP 67	IP 67	IP 67	IP 67
M8	M8	M8	M12 or pre-cabled	M12	M12 or pre-cabled (1)
XX512A1●	XX512A2●	XX●12A8●	XXV18B1●	XX518A1●	XX518A3● XXB18A3●
(2)					

Dimensions (mm)

Sensors with analogue output

Cylindrical type



Sensing distance Sn	
Assured operating distance (mm)	
Power supply	
Type of output	
Degree of protection	
Connection	
Sensor type	
Page	

50 cm	1 m
Adjustable using teach mode	Adjustable using teach mode
12...24 V $\overline{\text{---}}$ with protection against reverse polarity	12...24 V $\overline{\text{---}}$ or 24 V $\overline{\text{---}}$, depending on model, with protection against reverse polarity,
4-20 mA or 0-10 V	4-20 mA or 0-10 V
IP 67	IP 67
M12	M12
XX918A3●	XX●18●1AM12 XX●18●1VM12
(2)	31

(1) XXB18A3●: M12 connector only.
(2) Please refer to our catalogue "Ultrasonic sensors XX range".

Cylindrical type

Application, monitoring 2 levels

Ø 18 (M18 x 1) (continued)

Ø 30 (M30 x 1.5)

Ø 18 (M18 x 1)

Ø 30 (M30 x 1.5)



–	1 m	1 m	2 m/4 m depending on model	8 m	50 cm	1 m/2 m depending on model	8 m
–	–	1 m	–	–	–	–	–
61 cm/1 m	–	–	–	–	–	–	–
–	Adjustable using teach mode	Adjustable using teach mode			Adjustable using teach mode		
12...24 V $\overline{\text{---}}$ with protection against reverse polarity		12...24 V $\overline{\text{---}}$ with protection against reverse polarity			12...24 V $\overline{\text{---}}$ with protection against reverse polarity		
PNP/NPN	PNP	PNP or NPN or PNP/NPN		PNP or NPN	PNP or NPN	PNP/NPN	PNP
NO NC	NO or NC (selectable)	NO or NC or NO+NC or NO+NO		NO + NC	NO	NO + NO	NO + NO
IP 67	IP 67	IP 67	IP 67	IP 67	IP 67	IP 67	IP 67
M12	M12	M12	M12	M12	M12	M12	M12
XX●18A3● XX●18A4●	XX●18●1PM12	XX●30●●1PM12 XX6V3A1● XXBV3A1● XX630A1●	XX●30●●2PM12 XXS30●●4PM12 XX630A2●	XX630A3●	XX218A3●	XX230A1● XX230A2●	XX230A3●
(2)	31	(2)					

Ø 18 (M12 x 1) (continued)

Ø 30 (M30 x 1.5)



1 m	2 m	4 m	8 m
Adjustable using teach mode			
12...24 V $\overline{\text{---}}$ or 24 V $\overline{\text{---}}$, depending on model, with protection against reverse polarity			
4-20 mA or 0-10 V			
IP 67	IP 67	IP 67	IP 67
M12	M12	M12	M12
XX●30●1●M12 XX9V3A1● XX930A1●	XX●30●2●M12 XX930A2●	XXS30●4●M12	XX930A3●
(2)			

Applications Non-contact detection of sound reflecting objects regardless their shape, material, colour, orientation, etc.
Dimensions (mm)

Sensors with solid-state digital output

Flat format

7.6 x 19 x 33	16 x 30 x 74
----------------------	---------------------



Sensing distance Sn	Diffuse
	Reflex
	Thru-beam
Assured operating distance (mm)	
Power supply	
Type of output	
Function	
Degree of protection	
Connection	
Sensor type	
Page	

10 cm	–	25 cm	–
–	–	–	–
–	20 cm	–	61 cm/1 m
6.4...100 fixed	–	51...250 fixed	–
12...24 V $\overline{\text{DC}}$ with protection against reverse polarity			
NPN or PNP	NPN/PNP	NPN or PNP	NPN/PNP
NO	NO NC	NO	NO + NO NC + NC
IP 67	IP 67	IP 67	IP 67
M12 connector on flying lead	M12 connector on flying lead	M12	M12
XX7F1A2●	XX●F1A8●	XX7K1A2●	XX●K1A3● XX●K1A4●

Please refer to our catalogue "Ultrasonic sensors XX range"

Dimensions (mm)

Sensors with analogue output

Flat format

18 x 33 x 65 + Ø 18 (M18 x 1)



Sensing distance Sn	
Assured operating distance (mm)	
Power supply	
Type of output	
Degree of protection	
Connection	
Sensor type	
Page	

50 cm (adjustable)	
Adjustable using teach mode	
12...24 V $\overline{\text{DC}}$ with protection against reverse polarity	24 V $\overline{\text{DC}}$ with protection against reverse polarity
4-20 mA	0-10 V
IP 67	
M12	
XX9V1A1C2M12	XX9V1AF1M12

Please refer to our catalogue "Ultrasonic sensors XX range"

18 x 33 x 60 + Ø 18
(M18 x 1)



80 x 80 x 34



50 cm (adjustable)

1 m (adjustable)

50 cm (adjustable)

1 m (adjustable)

–

–

Adjustable using teach mode

12...24 V $\overline{\text{---}}$ with protection against reverse polarity

NPN or PNP

NPN or PNP

NO

NO

IP 67

IP 67

M12

M12

XX7V1A1●AM12
XXBV1A1PAM12

–

Please refer to our catalogue "Ultrasonic sensors XX range"

80 x 80 x 34



1 m (adjustable)

Adjustable using teach mode

12...24 V $\overline{\text{---}}$ with protection against reverse polarity

24 V $\overline{\text{---}}$ with protection against reverse polarity

4-20 mA

0-10 V

IP 67

M12

XX9D1A1C2M12

XX9D1A1F1M12

Please refer to our catalogue "Ultrasonic sensors XX range"

Feeder bowl supply control

XX7V1A1

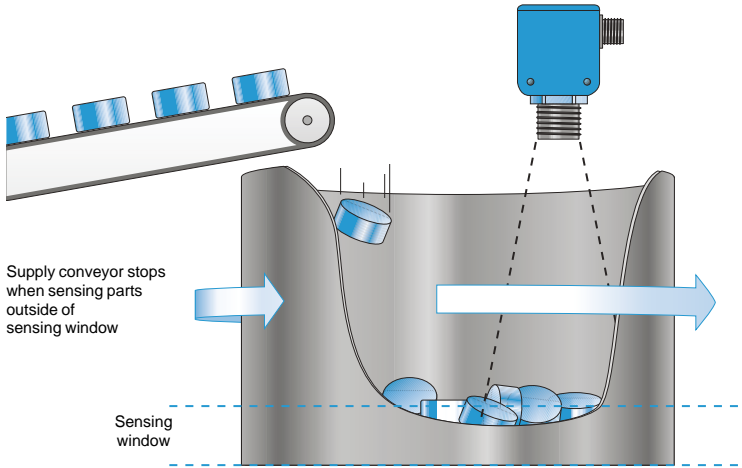

Conveyor jam & backup detection

XXB18A3

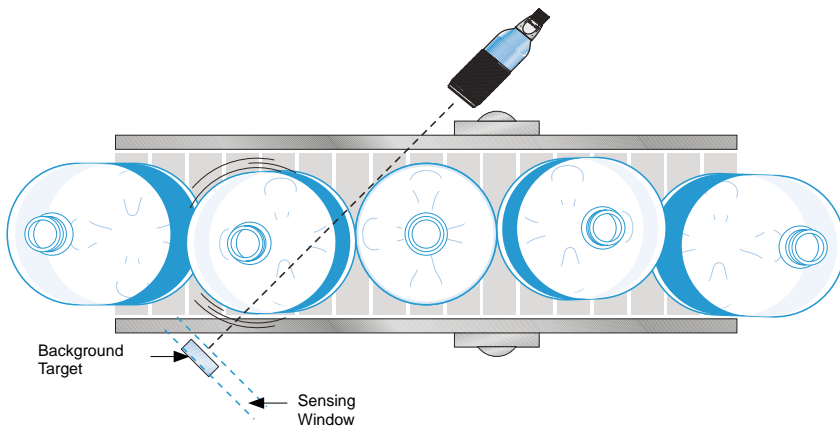

Web process control sensing functions

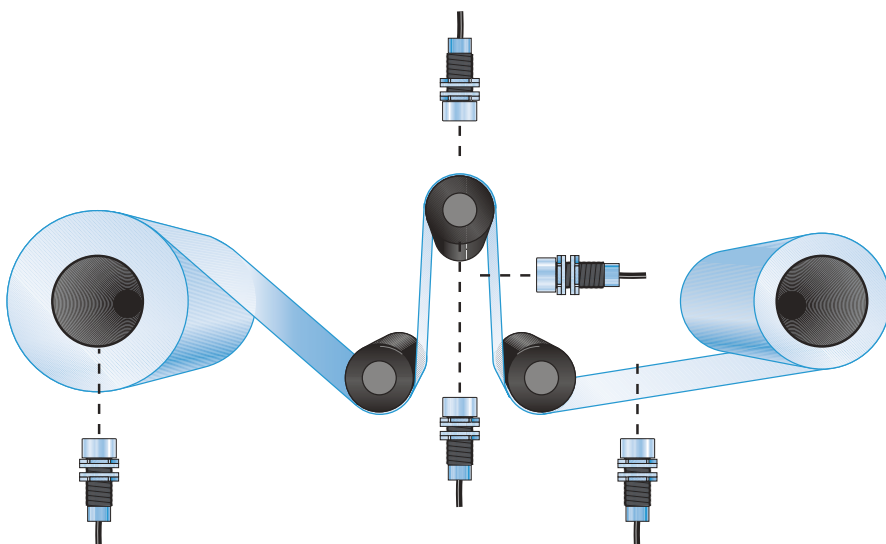

Dual level high-low latch control detection of liquids
XX230A3

High level detection
XX630A3

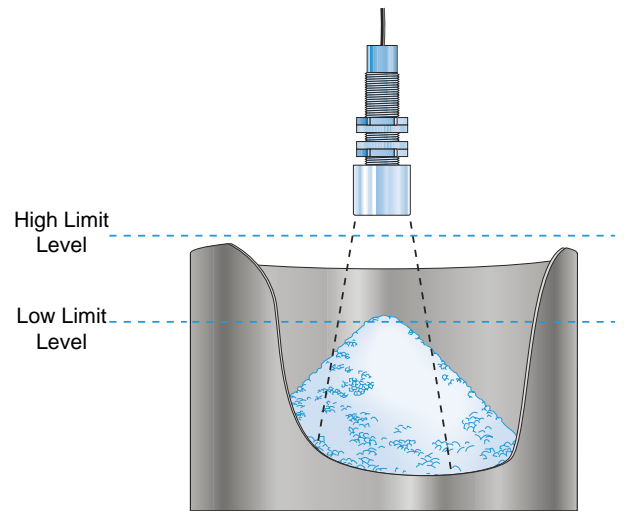
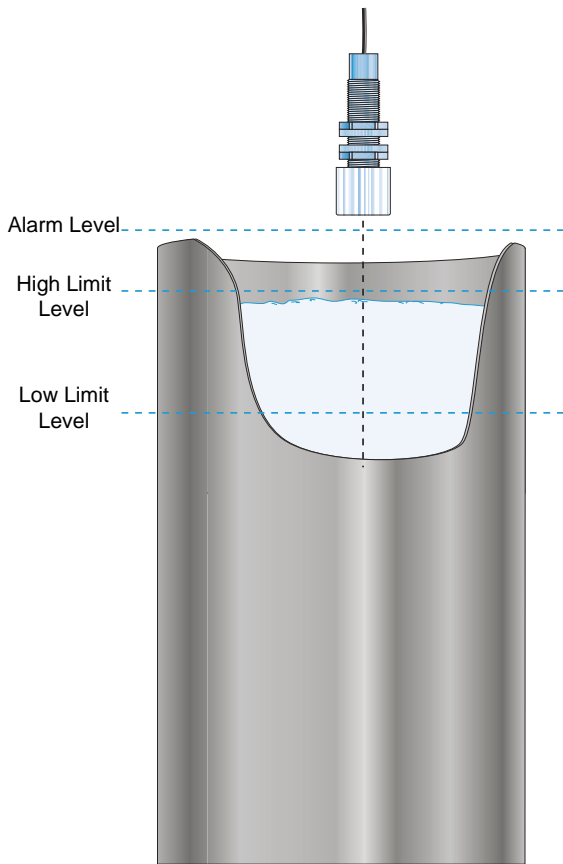

Accurate high speed counting of cylindrical clear objects
XXT18 + XXR18

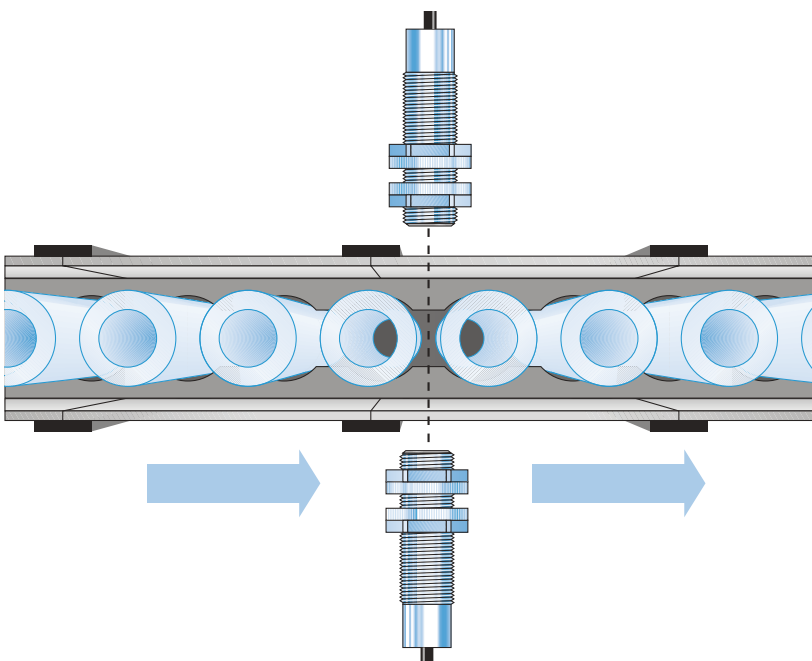

Glue bead detection

XXV18

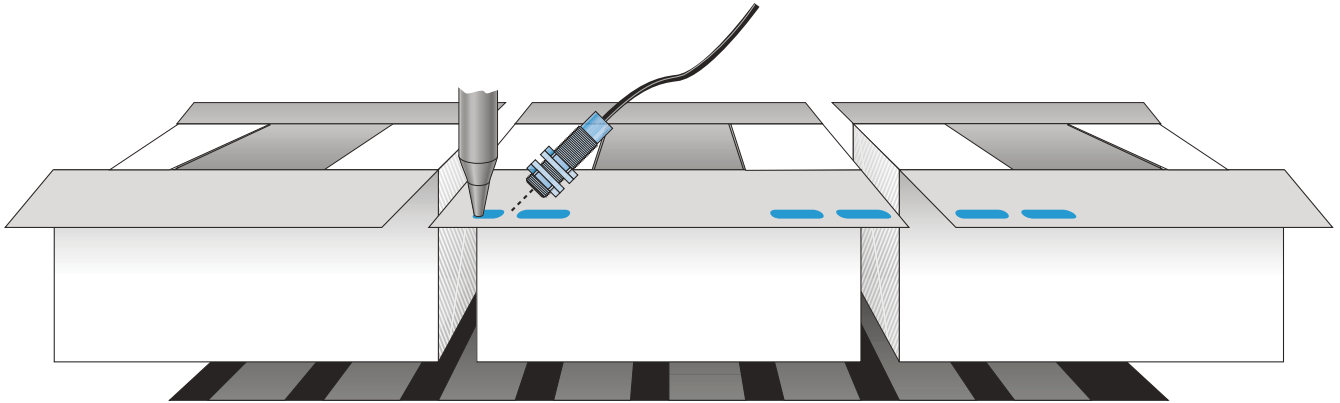

Label edge detection on carrier web

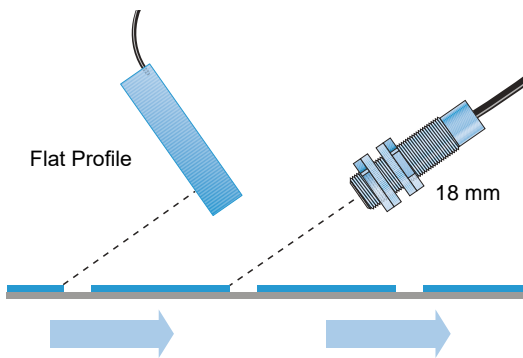

Clear bottle detection for sustainable environments

XXB18

Broken wire/thread detection

XXV18

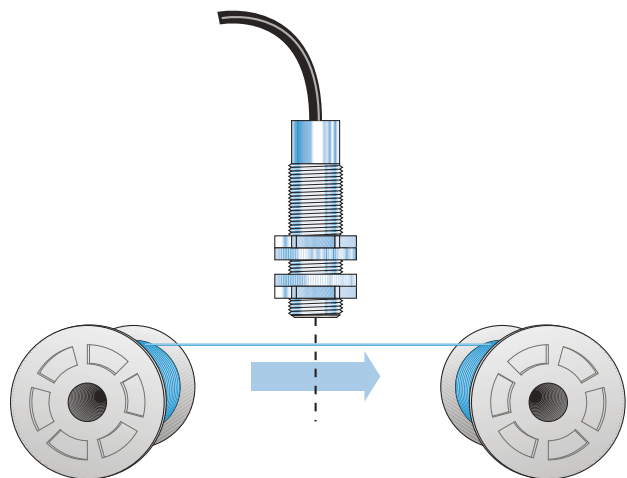
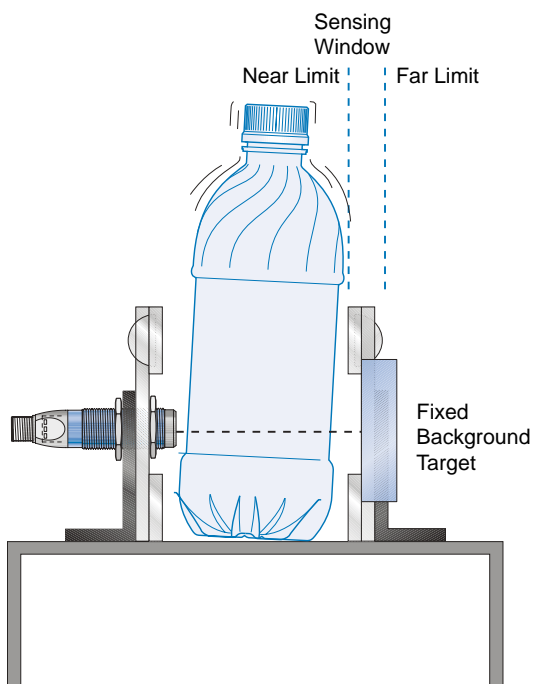

Missing cap detection low cap supply

XX512

Automatically stops filler and capper

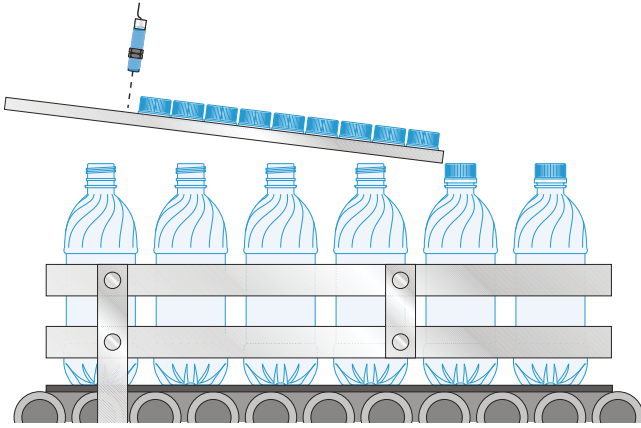

Continuous level monitoring

XX918 & XX930

Analog Output Sensor

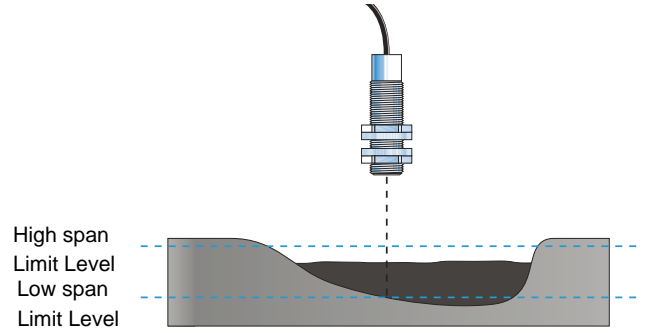

Dual level high-low latch control detection

XX230

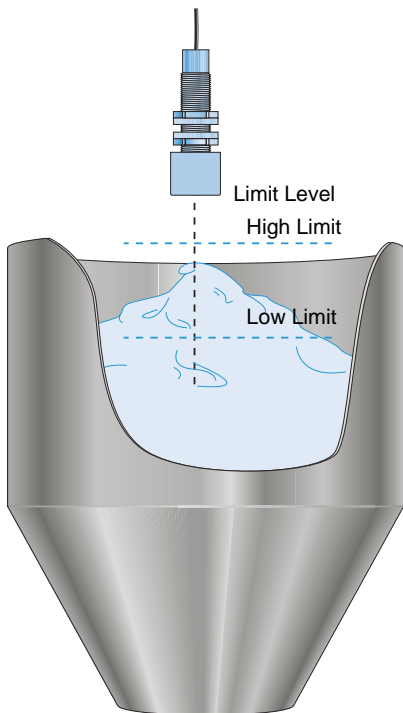

Lead edge or backup detection

XXT18 & XXR18

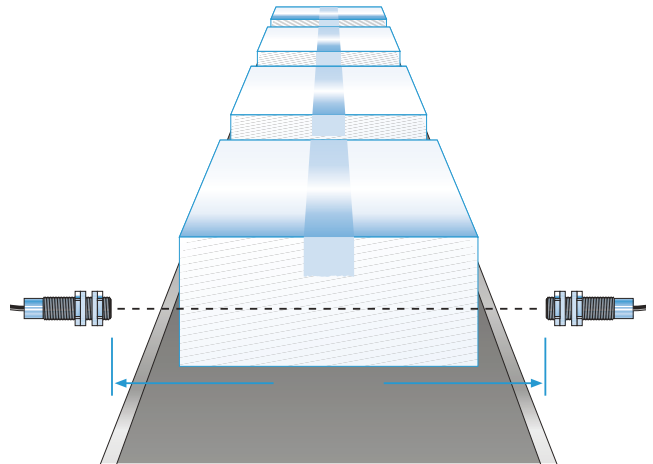

Clear bottle detection

XXT12 & XXR12

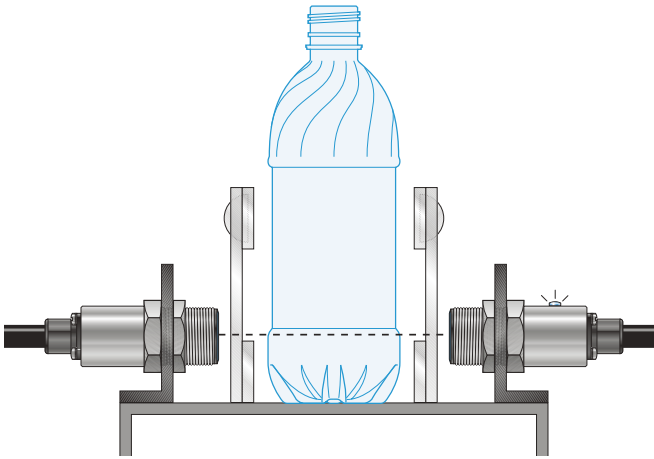

Container detection

XX7F1

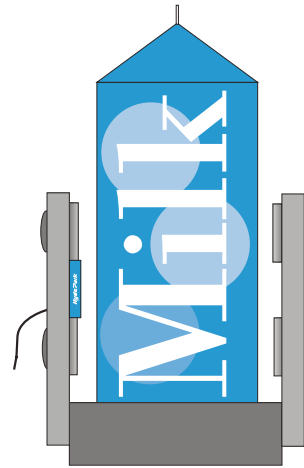

Metal material detection

XX512

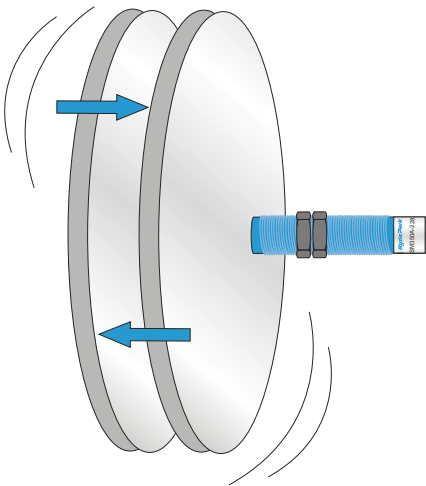

Missing cap detection

XX518

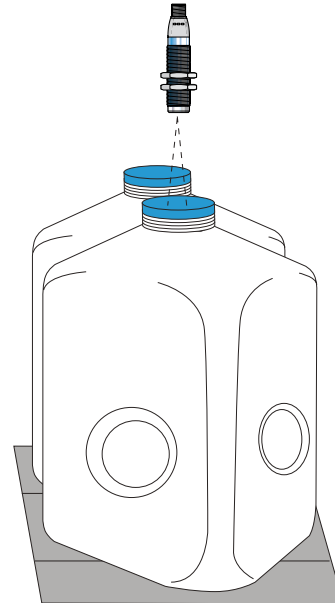

Clear web detection

XX512

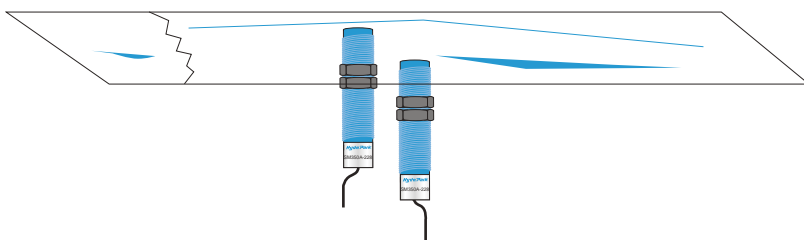

Container detection

XX7F1

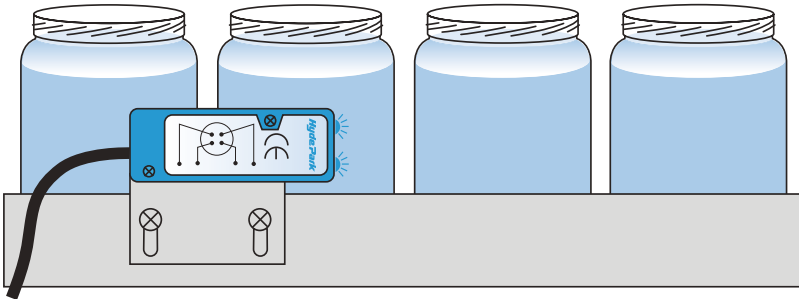

Clear cellophane panel detection

XX7F1A2

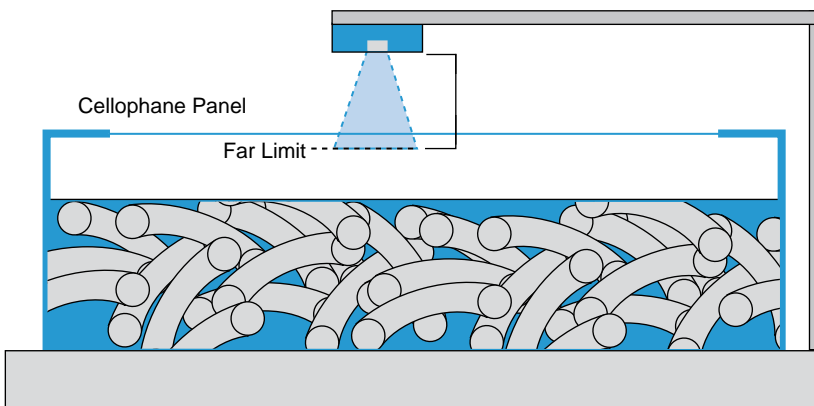

Single file jam protection

XX218 & XX230

Dual level latch control sensor

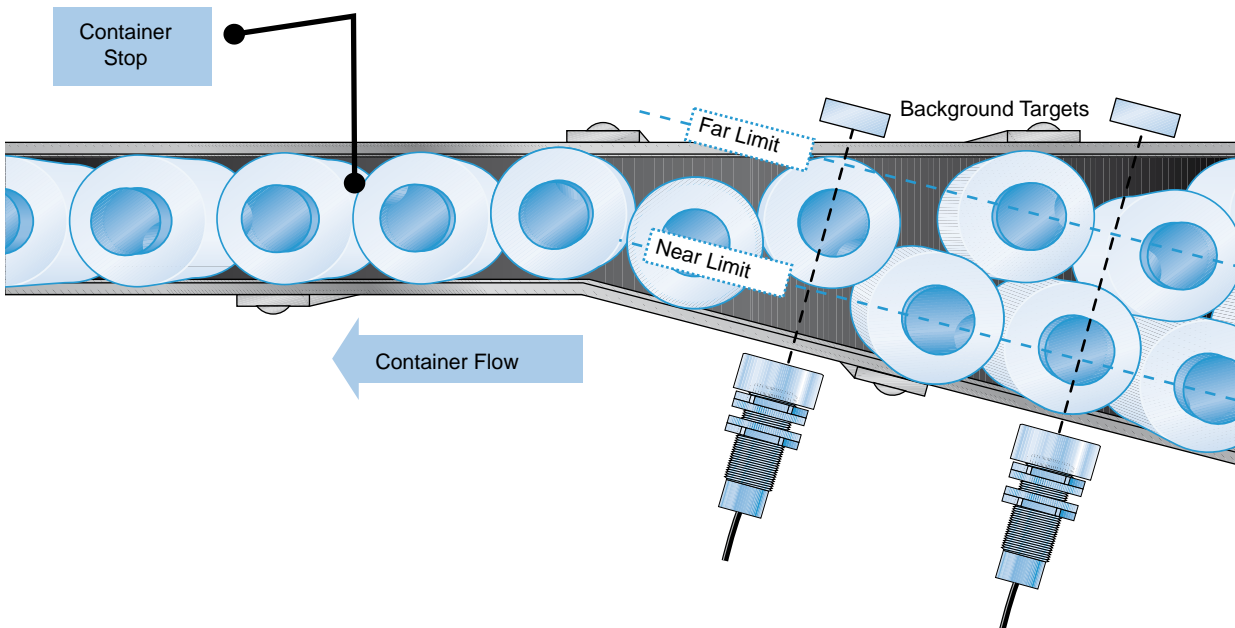

Quality, standards and certifications

Quality control

The XX ultrasonic sensors models are subjected to special precautions in order to guarantee their reliability in arduous industrial environments.

■ Qualification

A **qualification procedure** on the characteristics of XX range ultrasonic sensors is carried out in our laboratories.

■ Production

The electrical characteristics and the sensing distances at the ambient and operating temperatures are 100% verified.

Sensors are statistically selected during the course of production and subjected to **monitoring tests** on all qualified characteristics.

■ Customer returns

Returned ultrasonic sensors are subjected to systematic analysis and corrective actions are implemented to eliminate recurrence of the fault.

Conformity to standards

The XX ultrasonic sensors models conform to the standards IEC 60947-5-2.

Standards and characteristics: refer to pages 23, 28, 33, 38, 39, 42, 46, 54, 55, 62 and 66.

Resistance to chemicals in the environment

To ensure lasting efficient operation, it is essential that any chemicals coming into contact with the ultrasonic sensors will not affect their casing and, in doing so, prevent their reliable operation.

Due to the materials used, the XX ultrasonic sensors models are very resistant to:

■ Chemical agents:

salts, aliphatic and aromatic oils, petroleum, diluted bases and acids.

Depending on their nature and concentration, tests should be carried out beforehand for the following chemical agents:

alcohols, ketones and phenols.

■ Food and beverage industry products:

vegetable oils, animal fats, fruit juices,

milk proteins, etc.

Resistance to the environment

■ IP 65: protection against water jets.

Tested in accordance with IEC 60529: the device is subjected to water sprayed from a Ø 6.3 mm nozzle, at a flow rate of 12.5 litres/min for 3 min at a distance of 3 m.

No deterioration in either operating or insulation characteristics is permitted.

■ IP 67: protection against the effects of immersion.

Tested in accordance with IEC 60529: the sensor is immersed for 30 minutes in 1 m of water.

No deterioration in either operating or insulation characteristics is permitted.

■ IP 69K: protection against the effects of high pressure cleaning. Adherence to standard

DIN 40050 which stipulates that the product must withstand a water jet at a pressure of 90 bar and temperature of +80°C for 3 minutes.

No deterioration in either operating or insulation characteristics is permitted.

Recommendations

The ultrasonic sensors are designed for use in standard industrial applications involving presence detection. Since these sensors do not incorporate a redundant electrical circuit, they are not suitable for use in safety applications. For safety applications, please refer to our "Safety functions and solutions using Preventa" catalogue.

Principle of ultrasonic detection

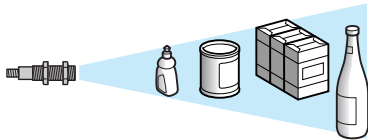

Presentation

Ultrasonic sensors enable detection, without contact, of objects irrespective of its:

- material (metal, plastic, wood, cardboard, etc.),
- nature (solid, liquid, powder, etc.),
- colour,
- degree of transparency.

They are used in industrial applications for detecting, for example:

- the position of machine parts,
- the presence of the windscreen during automobile assembly,
- the flow of objects on a conveyor system: glass bottles, cardboard packages, cakes, etc.,
- the level
 - of different colour paints in pots,
 - of plastic pellets in injection moulding machine feeders.

The ultrasonic sensors are simple to install due to their integral connector and availability of cabling and fixing accessories.

Operating principle

The principle of ultrasonic detection is based on measuring the time taken between transmission of an ultrasonic wave (pressure wave) and reception of its echo (return of transmitted wave).

The XX ultrasonic sensors models comprise:

- 1 a high voltage generator
- 2 a piezoelectric transducer (transmitter and receiver)
- 3 a signal processing stage
- 4 an output stage

Excited by the high voltage generator 1, the transducer (transmitter-receiver) 2 generates a pulsed ultrasonic wave (200 to 500 kHz depending on the product) which travels through the ambient air at the speed of sound. When the wave strikes an object, it reflects (echo) and travels back towards the transducer. A micro controller 3 analyses the signal received and measures the time interval between the transmitted signal and the echo. By comparison with the preset or taught times, it determines and controls the output states 4.

The output stage 4 controls a solid-state switch (PNP or NPN transistor) corresponding to a NO or NC contact (detection of object).

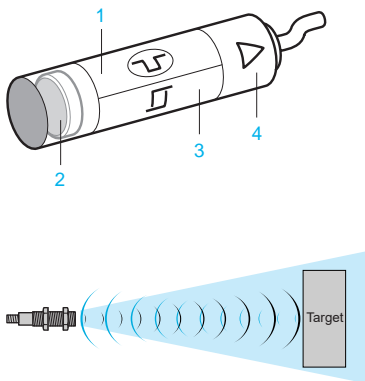

Advantages of ultrasonic detection

- No physical contact with the object to be detected, therefore, no wear and detection possible of fragile and/or freshly painted objects, etc.
- Detection of materials, irrespective of colour, at the same distance, without adjustment or correction factor.
- Teach mode function, by simply pressing a button, for defining the effective detection zone. Teaching of the minimum and maximum sensing distances (very precise foreground and background suppression, ± 6 mm).
- Very good resistance to industrial environments (robust products entirely encapsulated in resin).
- Solid-state units: no moving parts in the sensor, therefore, service life independent of the number of operating cycles.
- Various types of outputs to suit requirements:
 - Digital output for level control or detection of any type of object
 - Analogue output for controlling systems that require a signal that is proportional to the distance at which the object is detected.

Terminology

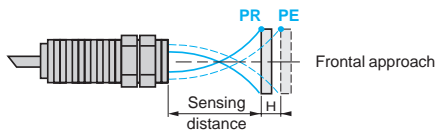
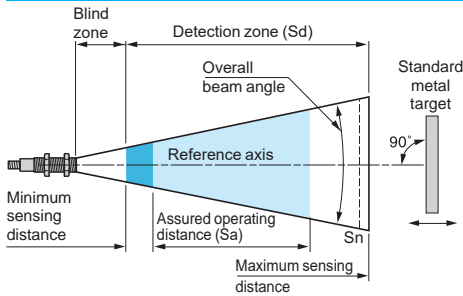

PR = drop-out point
PE = pick-up point

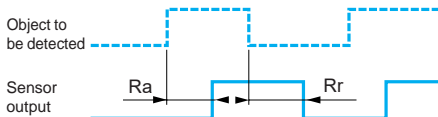
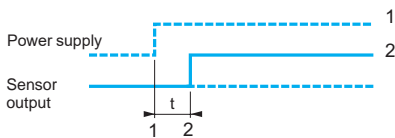
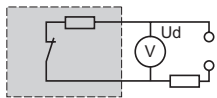

Definitions

The terms listed below are defined by the standard IEC 60947-5-2:

■ **Nominal sensing distance (Sn)**
Conventional value for indicating the sensing distance. It does not take into account manufacturing tolerances nor variations caused by external conditions such as voltage and temperature.

■ **Detection zone (Sd)**
Zone in which the sensor is sensitive to objects.

■ **Minimum sensing distance**
Lower limit of the specified detection zone.

■ **Maximum sensing distance**
Upper limit of the specified detection zone.

■ **Assured operating distance (Sa)**
This corresponds to the operating zone of the sensor (activation of outputs), and is included in the detection zone. It is also known as the "detection window".
Its limits are fixed:

- at the factory for fixed sensing distance sensors,
- when setting-up within the application for sensors with teach mode.

■ **Blind zone:** Zone located in front of the sensing face of the sensor.
For diffuse sensors, it is the zone in which the object will not be reliably detected.
For reflex sensors, it is the zone in which the target (fixed background of machine for example) will not be reliably detected, but the object can be in this zone.
For thru-beam sensors, there is no blind zone.

■ **Differential travel**
The differential travel (H) or hysteresis is the distance between the pick-up point as the standard metal target moves towards the sensor and the drop-out point as it moves away from the sensor.

■ **Repeat accuracy**
The repeat accuracy (R) is the precision of reproduction between two successive measurements of the sensing distance, made in identical conditions.

■ **Overall beam angle**
Fixed angle around the reference axis of an ultrasonic proximity sensor.

■ **Standard metal target**
The standard IEC 60947-5-2 defines the standard target as a square metal plate, 1 mm thick with rolled finish, placed perpendicularly to the reference axis.
Its side dimension depends on the detection zone:

Detection zone (mm)	Size of target (mm)
< 300	10 x 10
300 < d < 800	20 x 20
> 800	100 x 100

■ **Voltage drop (Ud)**
The voltage drop (Ud) corresponds to the voltage at the terminals of the sensor when in the closed state (value measured at the nominal current of the sensor).

■ **First-up delay**
Time required to ensure operation of the sensor's output signal following power-up.
1 Power-up
2 Output signal state (0 or 1)

■ **Response time**
Response time (Ra): time taken between the instant the object to be detected enters the active zone and the changing of the output signal state. This time limits the passing speed of the target in relation to its dimensions.
Recovery time (Rr): time taken between the object being detected leaving the active zone and the changing of the output signal state. This time limits the interval between 2 objects.

Digital outputs

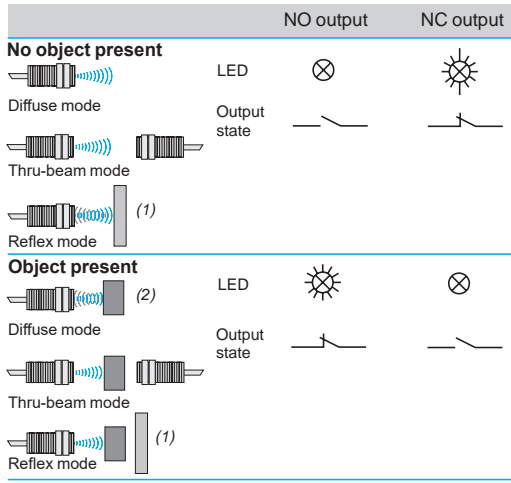

(1) Fixed background of machine
(2) Object

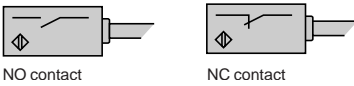

LED indicators

The majority of XX ultrasonic sensors models incorporate light-emitting diode output state indicators.

- Ø 12 sensor
 - Green LED (power on)
 - Yellow LED (object present)
- Ø 18 sensor, sensitivity 500 mm (except thru-beam versions XXT18 and XXR18)
 - Yellow LED (object present) or green LED (power on) + user assistance when adjusting the detection zone
- Ø 30 sensor
 - Multicolour LED for assisting the user when adjusting the detection distance
 - Yellow LED (object present)
 - Analogue version with LED (object present, with luminosity increasing as output signal increases)
- Parallelepiped format sensor
 - XX●F: Dual colour yellow (object present) or green (power on) LED
 - XX●V: Dual colour yellow (object present) or green (power on) LED + user assistance when adjusting the detection zone
 - XX7K: Yellow LED (object present); green LED (power on)
 - XXTK, XXRK: Yellow LED (object present) only
 - XX●D: Yellow LED (object present); green LED (power on)
 - Analogue version with LED (object present, with luminosity increasing as output signal increases)

Sensors with digital switching

Output contact logic

- NO contact (normally open)
Corresponds to a sensor whose output changes to the closed state when an object is present in the detection window.
- NC contact (normally closed)
Corresponds to a sensor whose output changes to the open state when an object is present in the detection window.

4-wire technique

NO output/PNP and NPN

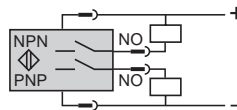

NO + NC output/NPN

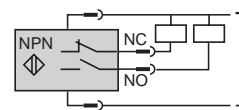

NO + NC output/PNP

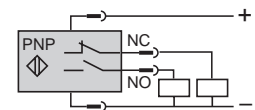

These sensors comprise 2 wires for the supply and 1 wire for each output signal

3-wire technique

NO output/NPN

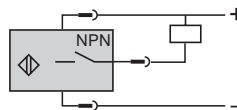

NO output/PNP

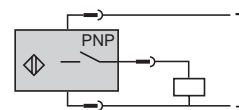

These sensors comprise 2 wires for the supply and 1 wire for the output signal,

- PNP type:** switching the positive side to the load.
- NPN type:** switching the negative side to the load.

Sensors with analogue output

Operation

The characteristic feature of these sensors is the output which delivers a signal (either current or voltage) that is proportional to the distance of the object being detected. Within the detection limits, which are adjustable using teach mode, the value of the output signal increases or decreases in relation to the distance of the object. When an object is detected, an LED indicator (D) illuminates and its luminosity increases in relation to the value of the output signal. The slope of the signal can simply be changed by pressing the teach button

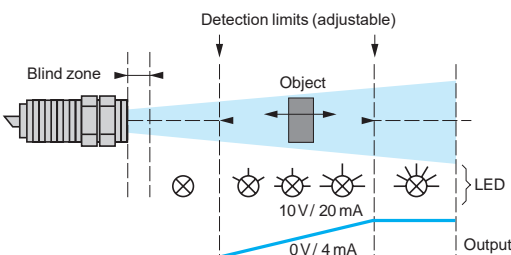

Advantages

- Visual information available relating to the sensor/object distance.
- Protection against reverse polarity.
- Protection against overloads and short-circuits.
- No residual current, low voltage drop.

Power supply

Sensors for DC circuits

- **DC source:** Check that the voltage limits of the sensor and the acceptable level of ripple, are compatible with the supply used.
- **AC source** (comprising transformer, rectifier, smoothing capacitor): The supply voltage must be within the operating limits specified for the sensor.

Where the voltage is derived from a single phase AC supply, the voltage must be rectified and smoothed to ensure that:

- the peak voltage of the DC supply is lower than the maximum voltage rating of the sensor.

Peak voltage = nominal voltage $\times \sqrt{2}$

- the minimum voltage of the supply is greater than the minimum voltage rating of the sensor,

given that:

$$\Delta V = (I \times t) / C$$

ΔV = max. ripple: 10% (V),

I = anticipated load current (mA),

t = period of 1 cycle (10 ms full-wave rectified for a 50 Hz supply frequency),

C = capacitance (μ F).

As a general rule, use a transformer with a lower secondary voltage (U_e) than the required DC voltage (U).

Example:

18 V \sim to obtain 24 V \dots ,

36 V \sim to obtain 48 V \dots .

Setting-up precautions

For diffuse sensors:

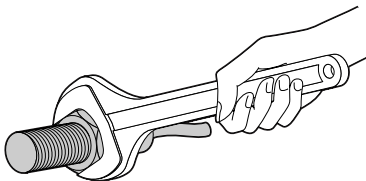
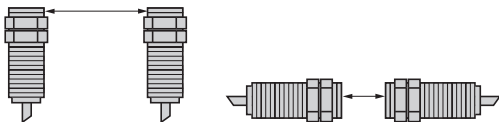

Mounting

Mounting distance between ultrasonic sensors

If 2 standard sensors are mounted too close to each other, the wave transmitted by one sensor is likely to interfere with the other and result in erratic operation.

In order to avoid this, it is necessary to adhere to the minimum distances between sensors. See setting-up precautions on page 25.

Maximum tightening torque

Cylindrical sensors	Diameter mm	Tightening torque	Flat sensors	Screw	Tightening Torque
XX●12●	Ø 12	0.7 N.m/ 0.52 lb-ft	XX●F●	M3	0.7 N.m/ 0.52 lb-ft
XX●18●	Ø 18	1 N.m/ 0.74 lb-ft	XX●K●	M4	1 N.m/ 0.74 lb-ft
XX●30●	Ø 30	1.35 N.m/ 1 lb-ft	XX●V●	M3	0.7 N.m/ 0.52 lb-ft
XX●V3●	Ø 30	1.35 N.m/ 1 lb-ft		Ø 18	1 N.m/ 0.74 lb-ft
XXS18*	Ø 18 (Plastic)	2 N.m /			
XXA18*		1.47 lb-ft			
	Ø 18 (Metal)	15 N.m /			
		11.06 lb-ft			

Interchangeability

Interchangeability is made easy by using **indexed** fixing clamps:

- XSZB112 (Ø 12 mm),
- XSZB118 (Ø 18 mm),
- XSZB130 (Ø 30 mm),
- XXZB118 (Ø 18 mm),

Cabling

Electrical connection

- **Connect the sensor before switching on the supply**

- **Length of cable**

No limitation up to 200 m or up to a line capacitance of < 0.1 μ F.

It is, however, advisable to take into account the voltage drop on the line.

- **Separation of control and power cables**

The sensors are immune to electrical interference encountered in normal industrial conditions. Where extreme conditions of electrical "noise" could occur (large motors, spot welders, etc.), it is advisable to protect against transients in the normal way:

- suppress interference at source,
- separate power and control wiring from each other,
- smooth the supply,
- limit the length of cable.

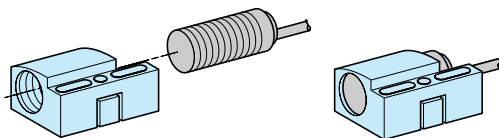

XSZB1●●

Setting-up precautions (continued)

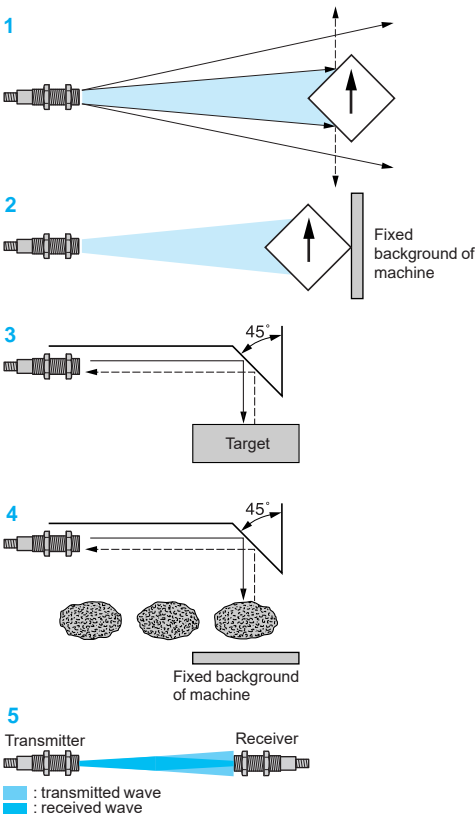
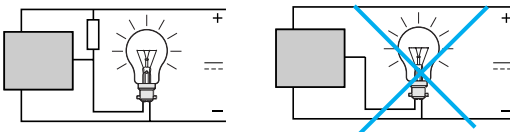
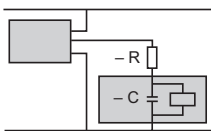
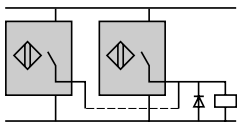
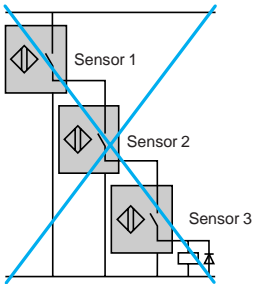

Connection in series

This connection method is not recommended.

- Correct operation of the sensors cannot be assured and, if this method is used, tests should be made before installation.

The following points should be taken into account:

Sensor 1 carries the load current in addition to the no-load current consumption values of the other sensors connected in series. For certain models, this connection method is not possible unless a current limiting resistor is used.

When in the closed state, each sensor will produce a voltage drop and, therefore, the load voltage should be selected accordingly.

As sensor 1 closes, sensor 2 will not operate until a certain time "T" has elapsed (corresponding to the first-up delay) and likewise for the following sensors in the sequence.

"Flywheel" diodes should be used when the load being switched is inductive.

Sensors and units in series with an external mechanical contact

- The following points should be taken into account:

When the mechanical contact is open, the sensor is not supplied.

When the contact closes, the sensor will not operate until a certain time "T" has elapsed (corresponding to the first-up delay).

Connection in parallel

- No specific restrictions. The use of "flywheel" diodes is recommended when an inductive load (relay) is being switched.

Capacitive load (C > 0.1 mF)

- At switch-on, it is necessary to limit (by resistor) the charging current of the capacitive load C. The voltage drop in the sensor can also be taken into account by subtracting it from the supply voltage for calculation of R.

$$R = \frac{U(\text{supply})}{I_{\text{max. (sensor)}}$$

Load comprising an incandescent lamp

- If the load comprises an incandescent lamp, the cold state resistance can be 10 times lower than the hot state resistance. This can cause very high current levels on switching. Fit a pre-heat resistance in parallel with the sensor.

$$R = \frac{U^2}{P} \times 10, U = \text{supply voltage and } P = \text{lamp power}$$

Detection

Influencing factors

The ultrasonic sensors are particularly suited for the detection of objects that are capable of reflecting an acoustic wave and, in general, having a flat surface perpendicular to the detection axis. However, the correct operation of the ultrasonic sensor can be disrupted by:

- air currents, which can accelerate or divert the acoustic wave transmitted by the sensor (ejection of part by air jet),
- high temperature gradients within the detection zone: an object emitting considerable heat can create zones of varying temperature that will modify the propagation time of the wave and thus prevent reliable operation,
- sound insulators: sound absorbing materials (cotton, fabrics, rubber, etc.),
- the angle between the face of the object to be detected and the reference axis of the sensor: when the angle is offset from 90°, the wave is no longer reflected back along the sensor axis and the operating distance is reduced. The greater the distance between the sensor and the target, the greater the effect. Detection is not possible when the angle exceeds ± 10°.
- the shape of the object to be detected: similar to the example above, an excessively angular object can be difficult to detect 1. In this case, use reflex mode detection.

Detection systems

Diffuse mode

In this mode, it is the object itself that reflects the ultrasonic wave back to the sensor which, in turn, switches its output. It is the most widely used and the most simple mode. In this mode, the object will not be detected in the blind zone.

Reflex or beam break mode

The sensor is in a permanently detecting state on a fixed background of the machine and when the object to be detected breaks the acoustic beam the output switches state 2. This mode is particularly recommended in cases where the shape of the object changes (irregular, angular, non perpendicular) and also for objects that absorb sound (see above). This mode can be achieved by using a diffuse mode sensor (with background teaching) or, more simply, by using a ready to use reflex mode sensor.

In cases where space is restricted, a reflector 3 and 4, angled at 45°, can be used. This system can be used for both the diffuse and reflex modes. This reflector can be a flat part of the machine or a separate element. In this mode, the background of the machine must not be within the blind zone. But if the object is within this zone, it will be reliably detected.

Thru-beam mode

Detection is achieved using both a transmitter and receiver, with the transmitter permanently transmitting an acoustic wave to the receiver. The breaking of the beam by the presence of an object switches the output of the receiver. This mode provides long detection distances 5. In this mode there is no blind zone.

Ultrasonic sensors

XX range, General purpose
Cylindrical, plastic or metal
DC supply, solid-state output



XX512A1KAM8



XX518A1KAM12



XXV18B1PAM12



XX7F1A2NAL01M12

Diffuse system

M12 sensors (digital sensors – Diffuse, Thru-beam) and M18 sensors (digital sensors which are less than 0.5m – all Diffuse)

Sensors	Sensing distance (Sn) m	Function/output	Connection	Reference	Weight kg
Ø 12 Plastic	0.05	NO/PNP + NO/NPN	M8 connector	XX512A1KAM8	0.011
	0.1	NO/NPN	M8 connector	XX512A2NAM8	0.011
		NO/PNP	M8 connector	XX512A2PAM8	0.011

Thru-beam system

M12 sensors (digital sensors – Diffuse, Thru-beam) and M18 sensors (digital sensors which are less than 0.5m – all Diffuse)

Transmitter	0.2		M8 connector	XXT12A8M8	0.020
Receiver	0.2	NO/PNP + NO/NPN NC/PNP + NC/NPN	M8 connector	XXR12A8KAM8	0.020
			M8 connector	XXR12A8KBM8	0.020

M18 sensors (digital sensors which are less than 0.5m – all Diffuse)

Ø 18 Plastic	0.15	NO/PNP + NO/NPN	M12 connector	XX518A1KAM12	0.033		
	Ø 18 Metal	0.05	NO/NPN	Pre-cabled (L = 2 m)	XXV18B1NAL2	0.110	
Pre-cabled (L = 5 m)				XXV18B1NAL5	0.200		
Pre-cabled (L = 10 m)				XXV18B1NAL10	0.340		
M12 connector				XXV18B1NAM12	0.050		
NO/PNP				Pre-cabled (L = 2 m)	XXV18B1PAL2	0.110	
				Pre-cabled (L = 5 m)	XXV18B1PAL5	0.200	
				Pre-cabled (L = 10 m)	XXV18B1PAL10	0.340	
M12 connector					XXV18B1PAM12	0.050	
				NC/NPN	Pre-cabled (L = 2 m)	XXV18B1NBL2	0.110
					Pre-cabled (L = 5 m)	XXV18B1NBL5	0.200
Pre-cabled (L = 10 m)					XXV18B1NBL10	0.340	
M12 connector					XXV18B1NBM12	0.050	
	NC/PNP	Pre-cabled (L = 2 m)	XXV18B1PBL2	0.110			
		Pre-cabled (L = 5 m)	XXV18B1PBL5	0.200			
Pre-cabled (L = 10 m)		XXV18B1PBL10	0.340				
M12 connector		XXV18B1PBM12	0.050				

Fixed sensing distance sensors

7.6 x 19 x 33	0.10	NO/NPN	152 mm flying lead + M12 connector	XX7F1A2NAL01M12	0.040
		NO/PNP	152 mm flying lead + M12 connector	XX7F1A2PAL01M12	0.040
16 x 30 x 74	0.25	NO/NPN	M12 connector	XX7K1A2NAM12	0.050
		NO/PNP	M12 connector	XX7K1A2PAM12	0.050

Ultrasonic sensors

XX range, General purpose
Cylindrical, plastic or metal
DC supply, solid-state output

Sensor type	XX512A1●	XX512A2●	XX●12A8●	XXV18B1●	XXTF● XXRF●	XX518A1●	
General characteristics							
Conformity to standards	CE, IEC 60947-5-2						
Product certifications	UL	UL	UL	cULus	UL	cULus	
Nominal sensing distance (Sn)	m	0.05	0.1	0.2	0.05	0.2	0.15
Blind zone (in diffuse mode the object is not detected in this zone, in reflex mode the background is not detected in this zone)	mm	0...6.4	0...6.4	–	0...2	–	0... 19
Detection window	mm	Fixed			Fixed		
Detection system	Diffuse	●	●	–	●	–	●
	Reflex	–	–	–	–	–	–
	Thru-beam	–	–	●	–	●	–
Transmission frequency (transmitter resonance)	kHz	500			360	500	200
Differential travel	mm	< 0.7	< 0.7	–	< 3	–	–
Repeat accuracy	mm	± 0.7		± 0.79	± 1.5	± 0.79	
Overall beam angle (see detection lobe)		11°	10°	10°	10°	10°	20
Minimum size of object to be detected	Cylinder Ø (in mm), at distance (in mm)	Ø 2.5 at 38	Ø 2.5 at 50	Ø 12 at 200	Ø 2.5 at 20	Ø 12.2 at 200	Ø 1.6 at 63
	Deviation angle from 90° of the object to be detected	± 10°	± 10°	–	± 8°	–	± 10°
Materials	Case	ULTEM®			Nickel plated brass	ULTEM®	
	Sensing face (5)	Epoxy			Epoxy	Epoxy	Silicone
Connection	Connector	M8, 4-pin	M8, 3-pin	M8, 4-pin	M12, 4-pin	M12, 4-pin, on 152 mm flying lead	M12, 4-pin
	Pre-cabled (wire c.s.a.)	–	–	–	3 x 0.34 mm2/ AWG 22	–	–
Sensor type	XX512A1●	XX512A2●	XX●12A8●	XXV18B1●	XX518A1●		

Supply characteristics							
Rated supply voltage	V	12...24 V $\overline{\text{---}}$ with protection against reverse polarity					
Voltage limits (including ripple)	V	10...28 V $\overline{\text{---}}$			10...36 V $\overline{\text{---}}$	10...28 V $\overline{\text{---}}$	
Current consumption, no-load	mA	25	50	15	60		
Output characteristics							
LED indicators	Output state	Yellow LED				–	
	Power on	Green LED				–	
	Setting-up assistance	–	–	–	–	–	
Switching capacity (with overload and short-circuit protection)	mA	< 100			< 200	< 100	
Voltage drop	V	< 1 (NPN); < 1.5 (PNP); 1.1 for XX●12A8, < 2 for XXV18B1●; 0.5 for XX630A2●					
Maximum switching frequency	Hz	125	125	125	80	80	
Delays	First-up	ms	20	20	20	5	350
	Response	ms	2	3	0.4	4	3
	Recovery	ms	2	3	0.4	4	3

Environment characteristics						
Degree of protection	Conforming to IEC 60529 and IEC 60947-5-2	IP 67			IP 65, IP 67 or (6)	IP 67
Storage temperature	°C	- 40...+ 80				
Operating temperature	°C	- 20...+ 65			0...+ 60	0...+ 50
Vibration resistance	Conforming to IEC 60068-2-6	Amplitude ± 1 mm (f = 10...55 Hz); ± 2 mm for XXV18B1●				
Mechanical shock resistance	Conforming to IEC 60068-2-27	30 gn, duration 11 ms, in all 3 axes 50 gn, duration 11 ms, in all 3 axes for XXV18B1●				
Resistance to electromagnetic interference		Conforming to IEC 60947-5-2				

(1) Only XX518A3● sensors are cCSAus certified.
(2) Only XX6V3A1●, XX630A1●, XX630A2●, XX630S1● and XX630A3● sensors are cCSAus certified.
(3) The first value is given for XX●18A3●, the second value for XX●18A4●.
(4) The first value is given for XX630A1● and XX630S1●, the second value for XX630A2●.
(5) Silicone face for optimum chemical resistance.
(6) Double insulation for pre-cabled sensors. IP 69K for sensors with M12 connector.

Ultrasonic sensors

XX range, General purpose

Cylindrical, plastic or metal

DC supply, solid-state output

Dimensions

XX●12A●●●M8

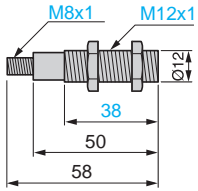

XX518A1KAM12

XXT18A●M12

XXR18A●●●●●

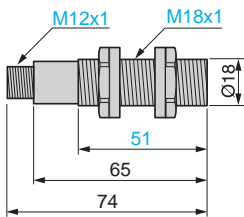

XXV18B1●●●M12

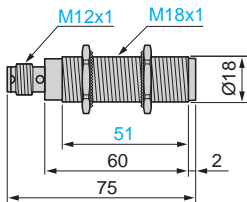

XXV18B1●●●L●

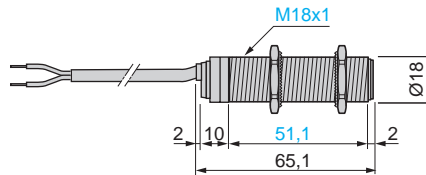

XX7F1A2●AL01M12

XXTF1A8●/XXR F1A8●

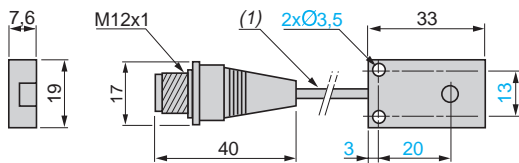

XX7K1A2●AM12

XXTK1A3●/A4●, XXRK1A3●/A4●

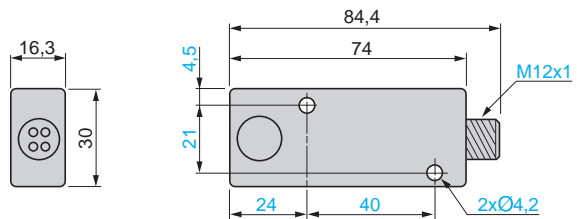

(1) Cable, length: 152 mm.

Setting-up precautions

Minimum mounting distances

Diffuse sensors, cylindrical type

Side by side

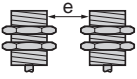

Face to face

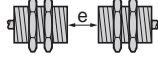

e: respect the distances indicated on the detection curves

$$e \geq 4 \times S_n$$

Diffuse sensors, flat format

Side by side

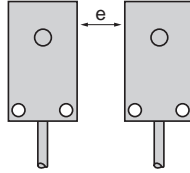

e: respect the distances indicated on the detection curves

XXV18●

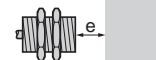
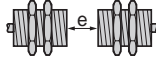
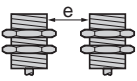

e > 25 mm

e > 700 mm

e > 60 mm

Thru-beam sensors

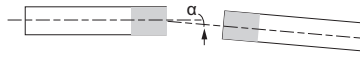

Sensors	α
XX●12●●/XX●F1●●	$\pm 5^\circ$
XX●18A3●●/XX●K1A3●●●	$\pm 8^\circ$
XX●18A4●●/XX●K1A4	$\pm 10^\circ$
XX●18A2●●/XX●K1A2	

Curves

XX512A1KAM8

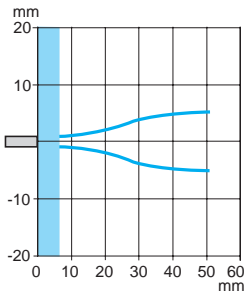

XX512A2●NAM8

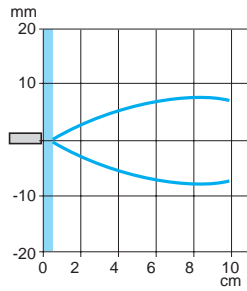

XX518A1KAM12

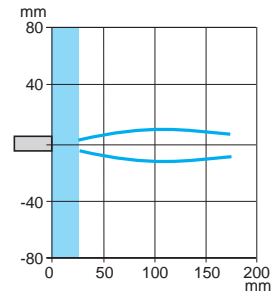

Schemes

Digital output, Ø 12 sensor, M8 connector

XX512A1KAM8

XX512A2●

4-wire type

NO outputs, PNP and NPN

3-wire type

NO outputs, NPN

NO outputs, PNP

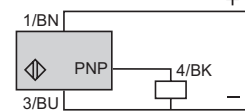
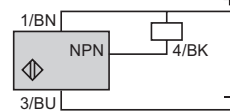
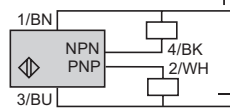
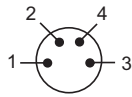

1 (+) 2 PNP output
3 (-) 4 NPN output

(-) BU (Blue) (+) BN (Brown)
WH (White) BK (Black)

1 (+) 3 (-)
4 NPN or PNP output

(-) BU (Blue) (+) BN (Brown)
BK (Black)

Digital output, Ø 18 sensor, M12 connector, Ø 30 (XX6V3●, XXBV3●)

XXV18B1●●M12

3-wire type

NO outputs, NPN

NO outputs, PNP

NC outputs, NPN

NC outputs, PNP

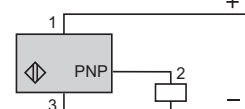
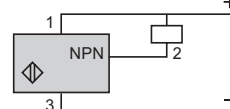
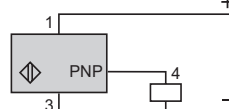
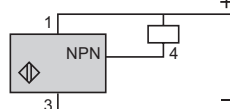
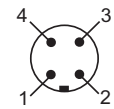

1 (+)
3 (-)

Digital output, Ø 18 sensor, pre-cabled

XXV18B1●●L●

XX518A3●●L2

3-wire type

PNP/NO, NC NPN/NO, NC

PNP output

NPN output

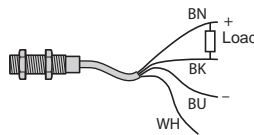
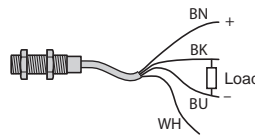
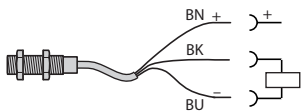

(-) BU (Blue) (+) BN (Brown) BK (Black)

Thru-beam sensors: XXT12●/XXR12●, XXT18●/XXR18●, XXTF1●/XXRF1●, XXTK1●/XXRK1●

Transmitter

XXT12A8M8, XXT18A3M12, XXTF1A8M12L, XXTK1A●M12

M8

M12

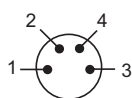
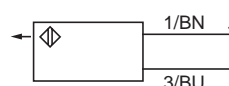

1 (+)
3 (-)

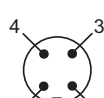

1 (+)
3 (-)

Receiver

XXR12A8K●M8, XXRF1A8●K●M12L, XXRK1A●K●M12

M8

M12

NPN, PNP, NO

NPN, PNP, NC

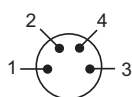

1 (+)
2 (PNP)
3 (-)
4 (NPN)

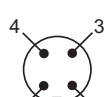

1 (+)
2 (PNP)
3 (-)
4 (NPN)

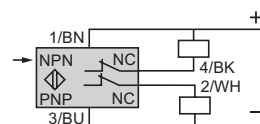
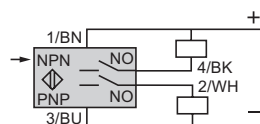

Ultrasonic sensors

XX range, General purpose
Cylindrical, plastic or metal
DC supply, solid-state output



XX518A3NAL2



XX8D1A1NAM12



XX918A3C2M12



XXT18A3M12



XX7V1A1NAM12



XXZPB100

Diffuse system

M18 sensors (digital (Diffuse) and analog sensors – 0.5 m) and Thru-beam (digital sensors 61 cm and 1 m)

Sensors	Sensing distance (Sn) m	Function/output	Connection	Reference	Weight kg
Ø 18 Plastic	0.50 (adjustable)	NO/NPN	Pre-cabled (L = 2 m)	XX518A3NAL2	0.08
		NO/PNP	Pre-cabled (L = 2 m)	XX518A3PAL2	0.08
	NO/NPN	M12 connector	XX518A3NAM12	0.033	
	NO/PNP	M12 connector	XX518A3PAM12	0.033	

Standard analogue output

Ø 18	0.5	4-20 mA		XX918A3C2M12	0.033
		0-10 V		XX918A3F1M12	0.033

Adjustable sensing distance sensors

18 x 33 x 60 + Ø 18	0.5 (adjustable)	NO/NPN	M12 connector	XX7V1A1NAM12	0.06
		NO/PNP	M12 connector	XX7V1A1PAM12	0.06
80 x 80 x 34	1 (adjustable)	NO/NPN	M12 connector	XX8D1A1NAM12	0.3
		NO/PNP	M12 connector	XX8D1A1PAM12	0.3

Thru-beam (digital sensors 61 cm & 1 m)

Ø 18

Transmitter	0.61		M12 connector	XXT18A3M12	0.04
Receiver	0.61	NO/PNP + NO/NPN	M12 connector	XXR18A3KAM12	0.04
		NC/PNP + NC/NPN	M12 connector	XXR18A3KBM12	0.04
Transmitter	1		M12 connector	XXT18A4M12	0.04
Receiver	1	NO/PNP + NO/NPN	M12 connector	XXR18A4KAM12	0.04
		NC/PNP + NC/NPN	M12 connector	XXR18A4KBM12	0.04

16 x 30 x 74

Transmitter	0.61		M12 connector	XXTK1A3M12	0.06
Receiver	0.61	NO/PNP + NO/NPN	M12 connector	XXRK1A3KAM12	0.06
		NC/PNP + NC/NPN	M12 connector	XXRK1A3KBM12	0.06
Transmitter	1		M12 connector	XXTK1A4M12	0.06
Receiver	1	NO/PNP + NO/NPN	M12 connector	XXRK1A4KAM12	0.06
		NC/PNP + NC/NPN	M12 connector	XXRK1A4KBM12	0.06

Accessories

Teach pushbutton

Teach pushbutton	For use with sensors	Reference	Weight kg
Selection of detection window Length of cable: 152 mm Input: M12 female connector Output: M12 male connector	XX918A● XX9V3A● XX9D1A●	XXZPB100	0.035

Ultrasonic sensors

XX range, General purpose
Cylindrical, plastic or metal
DC supply, solid-state output

Sensor type		XX●18A3● XX18A4●	XX518A3● XXB18A3●	XXTK● XXRK●	XX7V● XXBV1●	XX8D● XXBD●	
General characteristics							
Conformity to standards		CE, IEC 60947-5-2					
Product certifications		UL	UL, cCSAus (1)	UL	UL, cCSAus (1)	UL, cCSAus (1)	
Nominal sensing distance (Sn)		m	0.60 or 1 (3)	0.50	0.6 (XX●K1A3) 1 (XX●K1A4)	0.5	1
Blind zone (in diffuse mode the object is not detected in this zone, in reflex mode the background is not detected in this zone)		mm	–	0 ... 51 (XX518A3●) 0 ... 165 (XXB18A3●)	–	0 ... 51 (XX7V1●) 0 ... 165 (XXBV1●)	0 ... 100 (XX8D●) 0 ... 315 (XXBD●)
Detection window		mm	Fixed	Remotely adjustable or by using external teach button	Fixed	Remotely adjustable or by using teach button	
Detection system	Diffuse		–	●	–	●	●
	Reflex		–	●	–	●	●
	Thru-beam		●	–	●	–	–
Transmission frequency (transmitter resonance)		kHz	300	300	200	300	180
Differential travel		mm	< 2.5	< 2.5	–	< 2.5	< 2.5
Repeat accuracy		mm	± 1.27	± 1.27	± 0.79	± 1.27	± 1.6
Overall beam angle (see detection lobe)			6°	6°	20°	12°	7°
Minimum size of object to be detected			–	–	XX●K1A3: Cylinder Ø 38 mm at a sensing distance of 600 mm XX●K1A4: Cylinder Ø 114 mm at a distance of 1 m	Cylinder Ø 2.5 mm or flat bar 1 mm wide for a sensing distance of 150 mm	Cylinder Ø 50 mm up to 1 m
	Cylinder Ø (in mm), at distance (in mm)		Ø 38 at 600 Ø 114 at 1000	Ø 2.5 at 150	–	–	–
Deviation angle from 90° of the object to be detected			–	± 7°	–	–	–
Materials	Case		ULTEM®	Valox®	ULTEM®	Valox®	Valox®
			Stainless steel 303 for XX630AS1●●●● –				
	Sensing face (5)		Silicone	Epoxy	Silicone	Epoxy	Epoxy
Connection	Connector		M12, 4-pin	M12, 4-pin	M12, 4-pin	M12, 4-pin	M12, 4-pin
	Pre-cabled (wire c.s.a.)		–	4 x 0.08 mm 2/AWG 28	–	–	–

(1) Only XX518A3● sensors are cCSAus certified.

(2) Only XX6V3A1●, XX630A1●, XX630A2●, XX630S1● and XX630A3● sensors are cCSAus certified.

(3) The first value is given for XX●18A3●, the second value for XX●18A4●.

(4) The first value is given for XX630A1● and XX630S1●, the second value for XX630A2●.

(5) Silicone face for optimum chemical resistance.

Dimensions

XX7K1A2●AM12
XXTK1A3●/A4●, XXRK1A3●/A4●

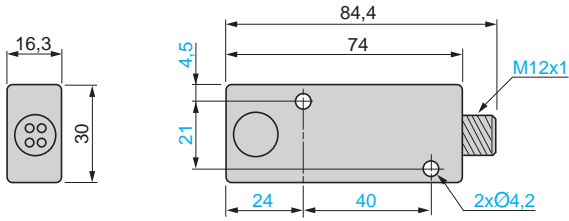

XX7V1A1●AM12
XXBV1A1●AM12

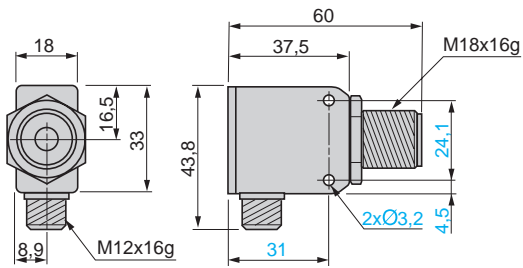

XX9V1A1●●M12

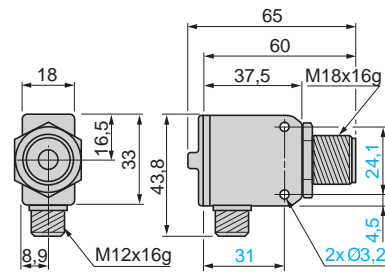

XX8D1A1●AM12
XXBD1A1●AM12
XX9D1A1●●AM12

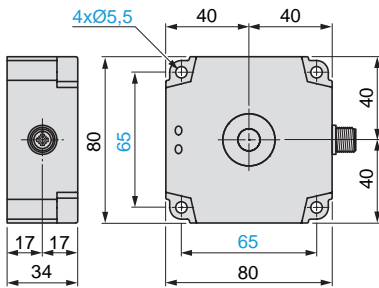

XXZPB100

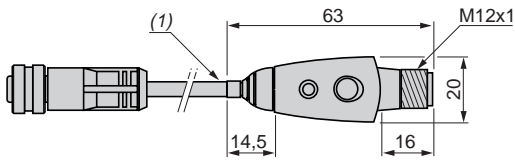

(1) Cable, length: 152 mm.

Setting-up precautions

Minimum mounting distances

Diffuse sensors, cylindrical type

Side by side

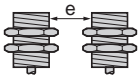

Face to face

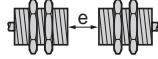

e: respect the distances indicated on the detection curves

$$e \geq 4 \times S_n$$

XXV18●

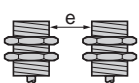

e > 25 mm

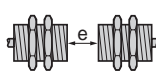

e > 700 mm

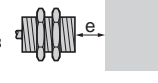

e > 60 mm

Diffuse sensors, flat format

Side by side

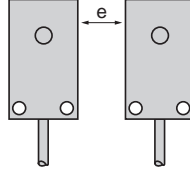

e: respect the distances indicated on the detection curves

Thru-beam sensors

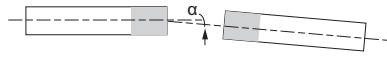

Sensors	α
XX●12●●/XX●F1●●	$\pm 5^\circ$
XX●18A3●●/XX●K1A3●●●	$\pm 8^\circ$
XX●18A4●●/XX●K1A4	$\pm 10^\circ$
XX●18A2●●/XX●K1A2	

Curves

XX218A3●●M12, XX518A3●●L2, XXB18A3●AM12, XX518A3●AM12
XX7V1A1●AM12, XXBV1A1●AM12
XX918A3●●M12, XX9V1A1●●M12

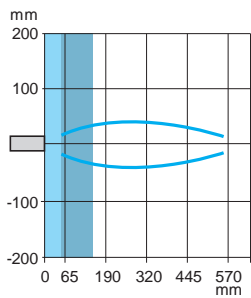

Blind zone for diffuse sensors.

Blind zone for reflex sensors.

Schemes

Digital output, \varnothing 18 sensor, M12 connector, \varnothing 30 (XX6V3●, XXBV3●)

XX518A3●, XXB18A3●, XX6V3●, XXBV3●, XX218A3●, XX7V1●, XXBV1●, XX8D1●, XXBD1●

3-wire type

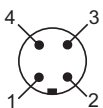

1 (+) 2 Teach input (WH)
3 (-) 4 NPN or PNP output

NO outputs, NPN

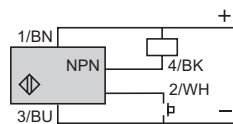

(-) BU (Blue) (+) BN (Brown)
BK (Black)

NO outputs, PNP

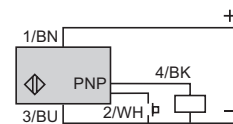

Ultrasonic sensors

XX range, General purpose

Cylindrical, plastic or metal, Ø 18 mm

Diffuse system, solid-state digital or analog output

Configurable by software



XXA18P1-M12



XXS18P1-M12



XXA18B1-M12
XXA18S1-M12



XXS18B1-M12
XXS18S1-M12



XXZPB100

Ultrasonic sensors

Sensors with solid-state digital output, M12 connector

Sensors	Sensing distance (Sn) Adjustable	Function/output	Sensing axis	Reference	Weight
					kg
Ø 18 Plastic	1	NO or NC (1) /PNP	Straight	XXS18P1PM12	0.033
			90° angled	XXA18P1PM12	0.040
Ø 18 Nickel-plated brass	1	NO or NC (1) /PNP	Straight	XXS18B1PM12	0.050
			90° angled	XXA18B1PM12	0.055
Ø 18 Stainless steel 316L	1	NO or NC (1) /PNP	Straight	XXS18S1PM12	0.050
			90° angled	XXA18S1PM12	0.055

Sensors with analog output, M12 connector

Sensors	Sensing distance (Sn) Adjustable	Analog output (2)	Sensing axis	Reference	Weight
					kg
Ø 18 Plastic	1	4-20 mA	Straight	XXS18P1AM12	0.033
			90° angled	XXA18P1AM12	0.040
		0-10 V	Straight	XXS18P1VM12	0.033
			90° angled	XXA18P1VM12	0.040
Ø 18 Nickel-plated brass	1	4-20 mA	Straight	XXS18B1AM12	0.050
			90° angled	XXA18B1AM12	0.055
		0-10 V	Straight	XXS18B1VM12	0.050
			90° angled	XXA18B1VM12	0.055
Ø 18 Stainless steel 316L	1	4-20 mA	Straight	XXS18S1AM12	0.050
			90° angled	XXA18S1AM12	0.055
		0-10 V	Straight	XXS18S1VM12	0.050
			90° angled	XXA18S1VM12	0.055

Accessories

Description	For use with sensor	Reference	Weight kg
Teach pushbutton Input: M12 female connector Output: M12 male connector	XXS18●● XXA18●●	XXZPB100	0.035

Configuration interface and configuration kit for the synchronization function

See page 34.

(1) Output function (NO or NC) and mode (window, reflex, proximity, pump) are selectable using the XXZPB100 remote teach pushbutton.

(2) Selectable using the XXZPB100 remote teach pushbutton.

Ultrasonic sensors

XX range, General purpose

Cylindrical, plastic or metal, Ø 18 mm

Diffuse system, solid-state digital or analog output

Configurable by software



Accessories

Description	Type	Length m	Reference	Weight kg
-------------	------	----------	-----------	-----------

Connection accessories for synchronization function

Pre-wired connector 5-pin, 5-wire female M12 connector/ bare wires PVC cable	Straight	2	XZCPV11V12L2	0.090
		5	XZCPV11V12L5	0.201
		10	XZCPV11V12L10	0.360
	Elbowed	2	XZCPV12V12L2	0.090
		5	XZCPV12V12L5	0.201
		10	XZCPV12V12L10	0.360

Connection accessories without synchronization function

Pre-wired connector 5-pin, 4-wire female M12 connector/ bare wires PVC cable	Straight	2	XZCP1141L2	0.090
		5	XZCP1141L5	0.190
		10	XZCP1141L10	0.370
	Elbowed	2	XZCP1241L2	0.090
		5	XZCP1241L5	0.190
		10	XZCP1241L10	0.370
Female M12 connector 5-pin, Pg 7 cable gland	Straight	–	XZCC12FDM50B	0.020
	Elbowed	–	XZCC12FCM50B	0.020

Mounting accessory

Description	For use with sensor	Reference	Weight kg
Fixing clamp (1)	XXS18●● XXA18●●	XXZB118	0.010

(1) Recommended to use in applications below 0°C.

Ultrasonic sensors

XX range, General purpose

Cylindrical, plastic or metal, Ø 18 mm

Diffuse system, solid-state digital or analog output

Configurable by software

Sensor type		XX●18●1PM12	XX●18●1AM12	XX●18●1VM12
General characteristics				
Conformity to standards		EN/IEC 60947-5-2, UL 508, and CSA C22.2 n°14		
Compliance with regulations		CE (based on EMC directive 2014/30/EU), NEC (ANSI/NFPA 70), CEC (CSA C22), UNECE R10		
Product certifications		cULus with class 2 power supply, E2, EAC, and RCM		
Nominal sensing distance (Sn)		m	1 (adjustable)	
Blind zone (in diffuse mode the object is not detected in this zone)		m	0.105	
Detection window		Remotely adjustable or by using external teachbutton XXZPB100		
Transmission frequency (transmitter resonance)		kHz	200	
Differential travel		mm	< 5	–
Repeat accuracy (repeatability)		0.1 %		
Minimum size of object to be detected		Cylinder Ø 1 mm up to sensing distance of 0.6 m		
Tilt angle with 100 x 100 mm target		± 7° at 1 m, ± 35° at 0.5 m, ± 10° at 0.9 m		
Materials	Case	XX●18P●●: PBT XX●18B●●: Nickel-plated brass XX●18S●●: Stainless steel 316L		
	Sensing face	Epoxy, polyurethane, and butyl		
Connection		M12 connector - 5-pin		
Supply characteristics				
Rated supply voltage (Ue) with protection against reverse polarity		V	12...24 V $\overline{\text{---}}$	24 V $\overline{\text{---}}$
Voltage limits (including ripple)		V	10...30 V $\overline{\text{---}}$	10...30 V $\overline{\text{---}}$
Current consumption, no-load		mA	< 30	< 30
Output characteristics				
LED indicators	Output state		Yellow LED	Yellow LED
	Echo state		Green LED	Green LED
Switching capacity (with overload and short-circuit protection)			< 100 mA	–
Resistive load impedance		Ω	–	12 V $\overline{\text{---}}$: load \leq 250 Ω 24 V $\overline{\text{---}}$: load \leq 850 Ω
Voltage drop		V	< 2	–
Internal temperature compensation			Yes	Yes
Maximum switching frequency		Hz	11	–
Delays	First-up	ms	120	180
	Response	ms	45	–
	Recovery	ms	45	100
Environment characteristics				
Degree of protection Conforming to IEC 60529 and EN/IEC 60947-5-2			IP 65, IP 67	
Storage temperature		°C	- 40...+ 80	
Operating temperature		°C	- 25...+ 70 (1)	
Relative humidity			< 95%, without condensation	
Vibration resistance Conforming to IEC 60068-2-6			Amplitude \pm 1 mm (f = 10...55 Hz)	
Mechanical shock resistance Conforming to IEC 60068-2-27			30 gn, duration 11 ms, in all 3 axes	
Resistance to electromagnetic interference			Conforming to EN/IEC 60947-5-2 and UNECE R10-05	

(1) For applications below 0°C, it is recommended to use the **XXZB118** fixing clamp (see page 36).

Ultrasonic sensors

XX range, General purpose
 Cylindrical, plastic or metal, Ø 18 mm
 Diffuse system, solid-state digital or analog output
 Configurable by software

Operating diagrams for digital output sensors

Settings with teach procedure

Window mode

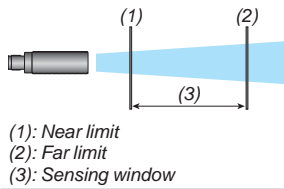

Reflex mode

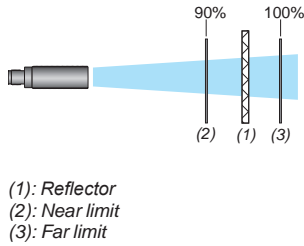

Proximity mode

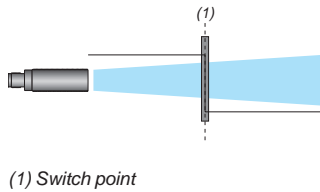

Pump/Hysteresis mode

Emptying (stored in high threshold memory)

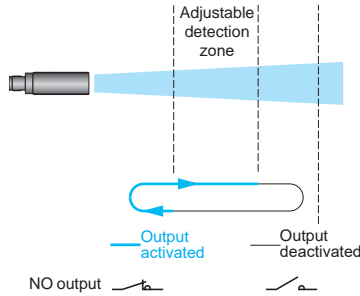

Filling (stored in low threshold memory)

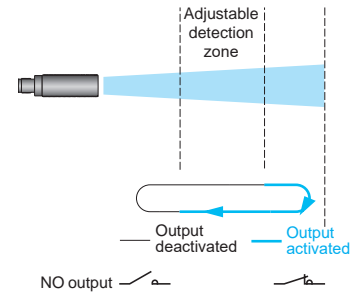

Operating diagram for analog output sensors

Near and far limits setting with teach procedure

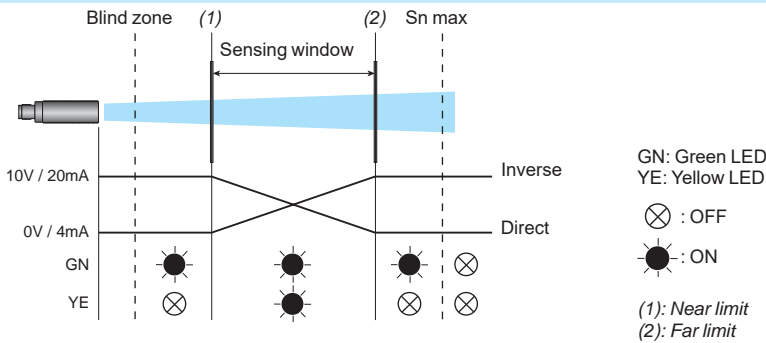
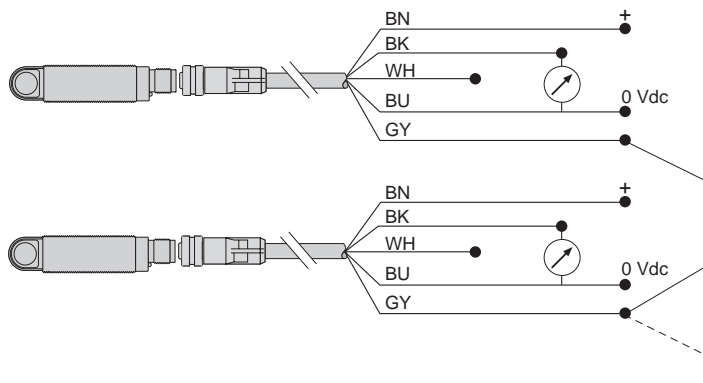

Diagram for the synchronization function (side by side application)



NB: To enable synchronization between several sensors, all of the wires of pin no.5 (gray) must be electrically connected together. A maximum of 8 sensors can be synchronized. To enable "Multiplexer" function for the sensors, use the XX Configuration Software. Without synchronization or multiplexing, the sensors must be at least 50 cm away from each other in order to avoid mutual interference.

Ultrasonic sensors

XX range, General purpose

Cylindrical, plastic or metal, Ø 18 mm

Diffuse system, solid-state digital or analog output

Configurable by software

Curves

Detection curve with 100 x 100 mm square target

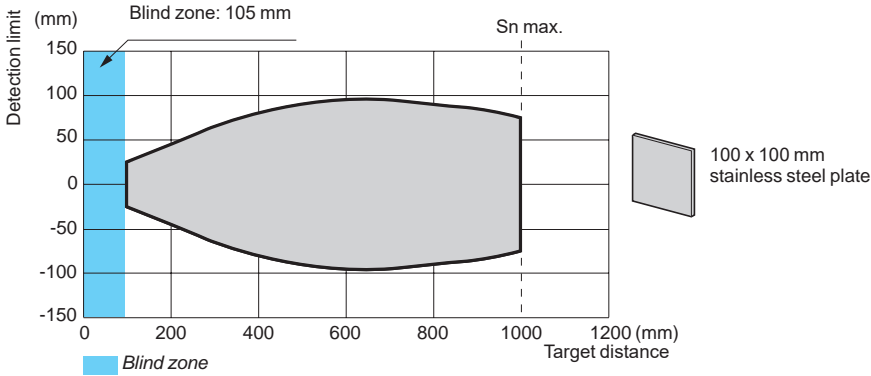

Detection curve with round bar

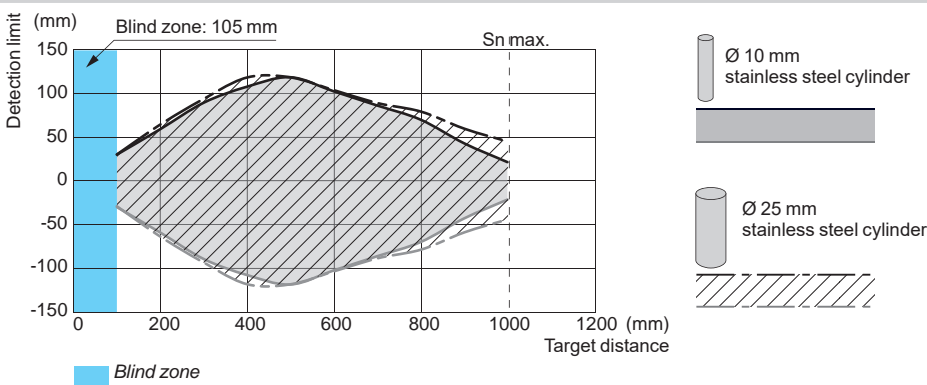

Dimensions

Plastic sensors, straight

XXS18P1•M12

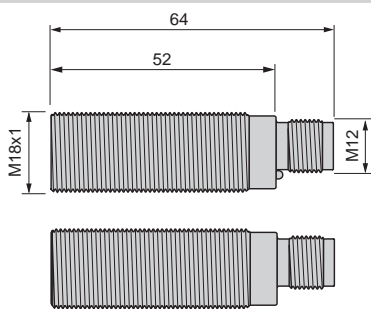

Plastic sensors, 90° angled

XXA18P1•M12

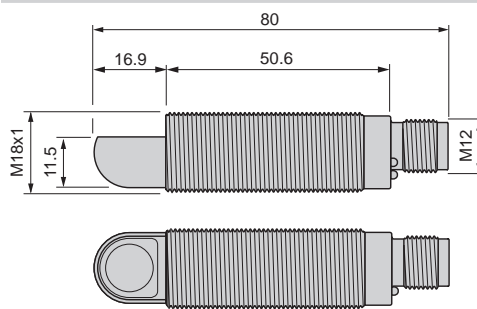

Nickel-plated brass and stainless steel sensors, straight

XXS18B1•M12 and XXS18S1•M12

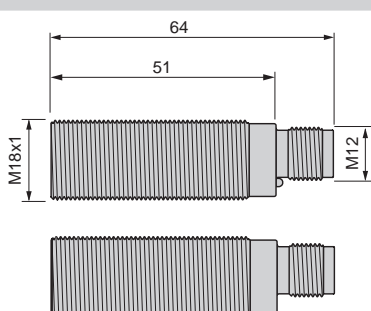

Nickel-plated brass and stainless steel sensors, 90° angled

XXA18B1•M12 and XXA18S1•M12

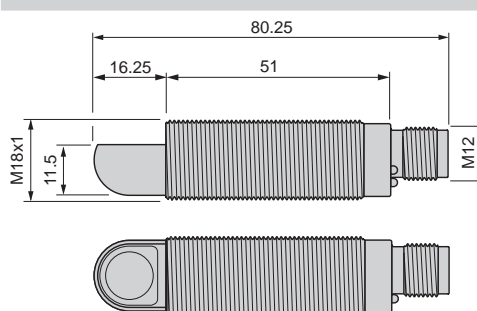

Ultrasonic sensors

XX range, General purpose
Cylindrical, plastic or metal, Ø 18 mm
Diffuse system, solid-state digital or analog output
Configurable by software

Dimensions (continued)

Fixing clamp XXZB118

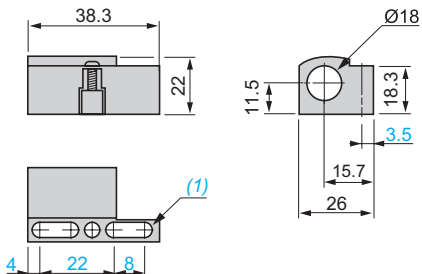

(1) 2 elongated holes Ø 4 X 8 mm

Teach pushbutton XXZPB100

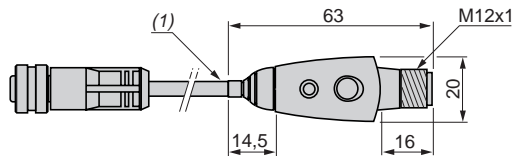

(1) Cable length: 152 mm

Connections

Connector wiring

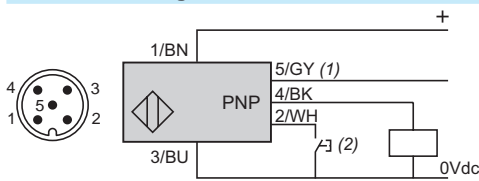

Pin number	Wire color	Digital output description	Analog output description	
			4-20 mA	0-10 V
1	BN: Brown	+12...24 V $\overline{\text{---}}$	+12...24 V $\overline{\text{---}}$	+14...24 V $\overline{\text{---}}$
2	WH: White	Input teach		
3	BU: Blue	0 V $\overline{\text{---}}$		
4	BK: Black	Output		
5	GY: Gray	Synchronization		

(1) Synchronization.

(2) External setting pushbutton or XXZPB100 remote teach pushbutton (see page 36).

Wiring scheme (digital output NO or NC)

XXS18•1PM12 and XXA18•1PM12

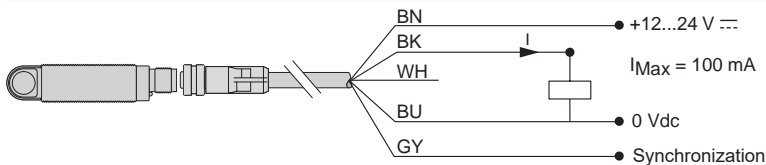

Wiring scheme (analog output 4-20 mA)

XXS18•1AM12 and XXA18•1AM12

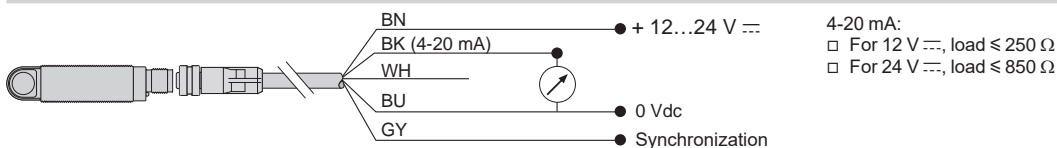

Wiring scheme (analog output 0-10 V)

XXS18•1VM12 and XXA18•1VM12

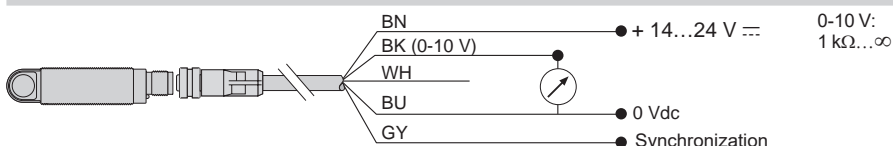

Ultrasonic sensors

XX range, General purpose
Cylindrical, plastic or metal
DC supply, solid-state output



XX630A1KAM12



XX6V3A1NAM12



XXBV3A1PAM12



XX930A3A2M12



XX930A1A2M12

Diffuse system

M30 sensors (digital & analog sensors – 1m, 2m, 8m) – Diffuse, Reflex

Sensors	Sensing distance (Sn) m	Function/output	Connection	Reference	Weight kg
Ø 30 Plastic	1 (adjustable)	NO/PNP + NO/NPN	M12 connector	XX630A1KAM12	0.09
		NO/NPN	M12 connector	XX6V3A1NAM12	0.09
		NO/PNP	M12 connector	XX6V3A1PAM12	0.09
		NO/NPN + NC/NPN	M12 connector	XX630A1NCM12	0.09
			M12 connector	XX630S1NCM12 (1)	0.09
		NO/PNP + NC/PNP	M12 connector	XX630A1PCM12	0.09
		M12 connector	XX630S1PCM12 (1)	0.09	
	2 (adjustable)	NO/NPN + NC/NPN	M12 connector	XX630A2NCM12	0.09
		NO/PNP + NC/PNP	M12 connector	XX630A2PCM12	0.09
	8 (adjustable)	NO/NPN + NC/NPN	M12 connector	XX630A3NCM12	0.11
		NO/PNP + NC/PNP	M12 connector	XX630A3PCM12	0.11

Reflex system

Ø 30 Plastic	1 (adjustable)	NO/PNP	M12 connector	XXBV3A1PAM12	0.09
--------------	----------------	--------	---------------	--------------	------

Standard analogue output

Sensors	Sensing distance (Sn) m	Analogue output (Slope selection using teach button)	Reference	Weight kg	
Ø 30	1	4-20 mA	XX930A1A2M12	0.095	
			XX930S1A2M12 (1)	0.095	
		0-10 V	XX930A1A1M12	0.095	
			XX930S1A1M12 (1)	0.095	
		4-20 mA	XX9V3A1C2M12	0.090	
		0-10 V	XX9V3A1F1M12	0.090	
	2	4-20 mA	XX930A2A2M12	0.095	
		0-10 V	XX930A2A1M12	0.095	
		8	4-20 mA	XX930A3A2M12	0.115
			0-10 V	XX930A3A1M12	0.115

250 ms delayed analogue output (for unstable object)

Ø 30	1	4-20 mA	XX930A1A2230M12	0.095
		0-10 V	XX930A1A1230M12	0.095
	2	4-20 mA	XX930A2A2230M12	0.095
		0-10 V	XX930A2A1230M12	0.095

Ultrasonic sensors

XX range, General purpose
Cylindrical, plastic or metal
DC supply, solid-state output

Sensor type	XX6V3A1● XXBV3A1●	XX630A1● XX630A2● XX630S1●	XX630A3●	XX930A1● XX930A2● XX930S1●	XX930A3●	XX9V3A1●	
General characteristics							
Conformity to standards	CE, IEC 60947-5-2			CE, IEC 60947-5-2			
Product certifications	UL, cCSAus (2)			UL, cCSAus			
Nominal sensing distance (Sn)	m	1	1 or 2 (4)	8	1 or 2 (6)	8	1
Blind zone (in diffuse mode the object is not detected in this zone, in reflex mode the background is not detected in this zone)	mm	0 ... 100 (XX6V3A1●) 0 ... 315 (XXBV3A1●)	0...51 (XX630●1) 0...120 (XX630A2●)	0...300	0...51 or 0...120 (6)	0...300	0...100
Detection window	mm	Remotely adjustable or by using external teach button	Adjustable using teach button on sensor	Adjustable using teach button on sensor	Adjustable using teach button on sensor	Remotely adjustable or by using external teach button	
Detection system	Diffuse	●	●	●	–	–	–
	Reflex	●	–	–	–	–	–
	Thru-beam	–	–	–	–	–	–
Transmission frequency (transmitter resonance)	kHz	180	200	75	200	75	180
Differential travel	mm	< 2.5	< 2.5	< 12.7			
Repeat accuracy	mm	± 1.6	± 0.87	± 2.54	± 0.9	± 2.54	± 0.9 1.6mm
Overall beam angle (see detection lobe)		7°	10°	16°	10°	16°	7°
Minimum size of object to be detected		Cylinder Ø 50 at distance 1000mm	Cylinder Ø 1.6 at distance 635mm	Cylinder Ø 51 at distance 4732mm	Cylinder Ø 1.6 mm up to a sensing distance of 635 mm	Cylinder Ø 50.68 mm up to a sensing distance of 4732 mm	Cylinder Ø 50 mm up to a sensing distance of 1 m
Deviation angle from 90° of the object to be detected		± 5°	± 7° or ± 10° (4)	± 5°	± 8°	± 5°	± 5°
Materials	Case	Valox®	ULTEM®	ULTEM®	ULTEM®: XX930A1● and XX930A2●	ULTEM®	Valox®
		Stainless steel 303 for XX630AS1●●●●			Stainless steel 303: XX930S1●	–	
	Sensing face (5)	Epoxy	Silicone	Epoxy	Silicone	Epoxy	
Connection	Connector	M12, 4-pin					
	Pre-cabled (wire c.s.a.)	–					

(1) Only XX518A3● sensors are cCSAus certified.

(2) Only XX6V3A1●, XX630A1●, XX630A2●, XX630S1● and XX630A3● sensors are cCSAus certified.

(3) The first value is given for XX●18A3●, the second value for XX●18A4●.

(4) The first value is given for XX630A1● and XX630S1●, the second value for XX630A2●.

(5) Silicone face for optimum chemical resistance.

(6) The first value is given for XX930A1● and XX930S1●, the second value for XX930A2●.

Ultrasonic sensors

XX range, General purpose
Cylindrical, plastic or metal
DC supply, solid-state output

Sensor type		XX6V3A1● XXBV3A1●	XX630A1● XX630A2● XX630S1●	XX630A3●	XX930A1● XX930A2● XX930S1●	XX930A3●	XX9V3A1●	
Supply characteristics								
Rated supply voltage	V	12...24 V $\overline{\text{---}}$ with protection against reverse polarity			15...24 V $\overline{\text{---}}$	15...24 V $\overline{\text{---}}$	15...24 V $\overline{\text{---}}$	
Voltage limits (including ripple)	V	10...28 V $\overline{\text{---}}$			10...28 V $\overline{\text{---}}$	–		
Current consumption, no-load	mA	60	50 or 100 (1)	50	60 or 80 (3)	60	60	
Output characteristics								
LED indicators	Output state	Yellow LED			Yellow LED	–		
	Power on	Green LED			Green LED	–		
	Setting-up assistance	Multicolour LED			Dual colour LED	–		
Slope type		–			Direct or inverse by using teach button, see page 36.			
Switching capacity (with overload and short-circuit protection)	mA	< 100			–	–		
Voltage drop	V	< 100			–	–		
Maximum switching frequency	Hz	70	10 or 16 (1)	2	–	–		
Delays	First-up	ms	75	720	800	720	1200	75
	Response	ms	15	20 or 25 (1)	200			
	Recovery	ms	75	20	200	250 (delayed) 50 (standard)	250	180
Resistive load impedance	4-20 mA	Ω	–			10...500		10...350
	0-10 V	Ω	–			1 k... ∞		2 k... ∞
Environment characteristics								
Degree of protection	Conforming to IEC 60529 and IEC 60947-5-2	IP 67	IP 65 or IP 67 (1) IP67 for plastic versions... IP65 for stainless steel versions	IP 67	IP 67	IP 67	IP 67	
Storage temperature	$^{\circ}\text{C}$	-40...+80						
Operating temperature	$^{\circ}\text{C}$	0...+70	0...+60 or 0...+50 (1)	-20...+60	0...+50	-20...+60	0...+70	
Vibration resistance	Conforming to IEC 60068-2-6	Amplitude \pm 1 mm (f = 10...55 Hz); \pm 2 mm for XXV18B1●			Amplitude \pm 1 mm (f = 10...55 Hz)			
Mechanical shock resistance	Conforming to IEC 60068-2-27	30 gn, duration 11 ms, in all 3 axes 50 gn, duration 11 ms, in all 3 axes for XXV18B1●			30 gn, duration 11 ms, in all 3 axes			
Resistance to electromagnetic interference		Conforming to IEC 60947-5-2						

(1) The first value is given for XX630A1● and XX630S1●, the second value for XX630A2●.

(2) Double insulation for pre-cabled sensors. IP 69K for sensors with M12 connector.

(3) The first value is given for XX930A1● and XX930S1●, the second value for XX930A2●.

Dimensions

XX630A1●●M12
XX630S1●●M12
XX630A2●●M12
XX930A1A●M12
XX230A1●●A00M12
XX230A2●●A00M12

XX6V3A1●AM12
XXBV3A1●AM12
XX9V3A1●●M12

XX630A3●●M12
XX930A3A●M12

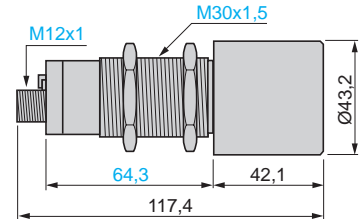
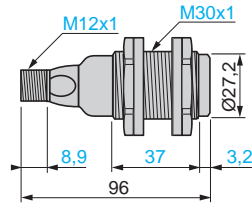
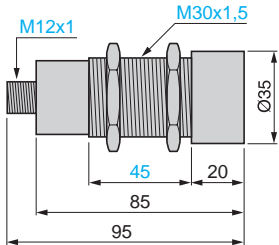

Curves

XXV18B1●

Square object

Cylindrical object

XX630A2●CM12

XX630A3●CM12
XX930A3●●M12

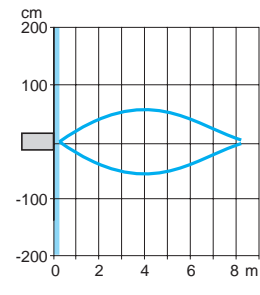
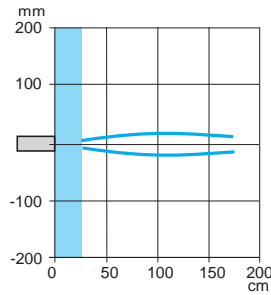
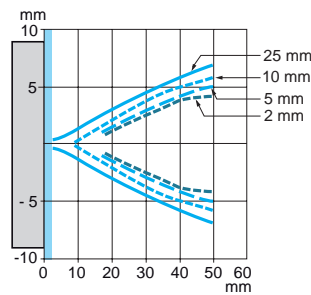
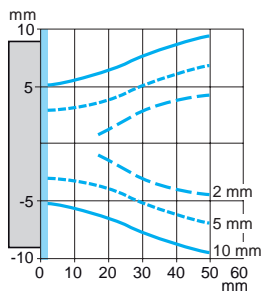

XX230A1●, XX630A1●CM12,
XX6V3A1●AM12, XXBV3A1●AM12,
XX930A1●●M12, XX9V3A1●●M12,
XX8D1A1●AM12, XXBD1A1●AM12

XX7F1A2●AL01M12

XX7K1A2●AM12

XX230A2●

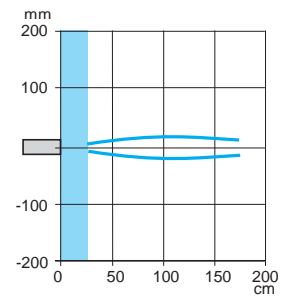
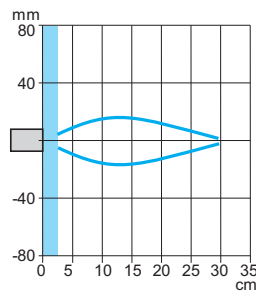
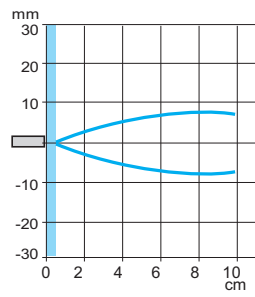
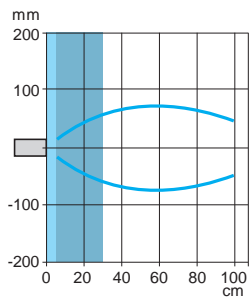

Blind zone for diffuse sensors.
 Blind zone for reflex sensors.

Ultrasonic sensors

XX range, Application

Sensors for monitoring 2 levels

Cylindrical plastic case, M18 x 1 and M30 x 1.5

DC supply, solid-state output

121364



XX218A3NHM12

121366



XX230A12NA00M12

Application - Sensors for monitoring 2 levels

Sensors	Sensing distance (Sn) m	Function/output	Reference	Weight kg
Ø 18, threaded M18 x 1				
2 emptying levels	0.5 (adjustable)	NO/NPN	XX218A3NHM12	0.035
		NO/PNP	XX218A3PHM12	0.035
2 filling levels	0.5 (adjustable)	NO/NPN	XX218A3NFM12	0.035
		NO/PNP	XX218A3PFM12	0.035
Ø 30, threaded M30 x 1.5				
2 levels 2 independent outputs	1 (adjustable)	NO/NPN + NO/NPN	XX230A12NA00M12	0.090
		NO/PNP + NO/PNP	XX230A12PA00M12	0.090
	2 (adjustable)	NO/NPN + NO/NPN	XX230A22NA00M12	0.090
		NO/PNP + NO/PNP	XX230A22PA00M12	0.090
2 emptying levels	1 (adjustable)	NO/PNP + NO/PNP	XX230A10PA00M12	0.090
	2 (adjustable)	NO/PNP + NO/PNP	XX230A20PA00M12	0.090
2 filling levels	1 (adjustable)	NO/PNP + NO/PNP	XX230A11PA00M12	0.090
	2 (adjustable)	NO/PNP + NO/PNP	XX230A21PA00M12	0.090

Accessories

Teach pushbutton

Teach pushbutton	For use with sensors	Reference	Weight kg
Selection of detection window Length of cable: 152 mm Input: M12 female connector Output: M12 male connector	XX218A3●	XXZPB100	0.035

Other connection and fixing accessories

See page 48.

Sensor type		XX218A3●●●●	XX230A1●●●●	XX230A2●●●●
General characteristics				
Conformity to standards		CE, IEC 60947-5-2		
Product certifications		UL, cCSAus	UL, cCSAus	UL, cCSAus
Nominal sensing distance (Sn)		m 0.50 (adjustable)	1 (adjustable)	2 (adjustable)
Blind zone (no object must pass through this zone whilst the sensor is operating)		mm 0...51	0...51	0...120
Detection window		Remotely adjustable or by using external teach button	Adjustable using teach button on sensor	
Transmission frequency		kHz 300	200	
Differential travel		mm < 2.5	< 2.5	< 2.5
Repeat accuracy		mm ± 1.27	± 0.9	
Overall beam angle (see detection lobe)		6°	10°	10°
Minimum size of object to be detected		Cylinder Ø 2.5 mm up to a sensing distance of 150 mm	Cylinder Ø 1.6 mm up to a sensing distance of 305 mm	
Deviation angle from 90° of the object to be detected		± 7°	± 10° on 305 x 305 mm	
Materials		Case	Valox®	ULTEM®
		Sensing face (1)	Epoxy	Silicone
Connection		Connector	M12, 4-pin	
Supply characteristics				
Rated supply voltage		V 12...24 V $\overline{\text{---}}$ with protection against reverse polarity		
Voltage limits (including ripple)		V 10...28 V $\overline{\text{---}}$		
Current consumption, no-load		mA 40	100	
Output characteristics				
LED indicators		Output state	Yellow LED	Multicolour LED
		Power on	Green LED	–
		Setting-up assistance	Dual colour LED	Multicolour LED
		Distance indication	–	Yellow LED
Switching capacity		mA < 100 (PNP and NPN) with overload and short-circuit protection		
Voltage drop		V < 1 (PNP and NPN)		
Delays		First-up	ms 100	1000
		Response	ms 15	150
		Recovery	ms 1000	1000
Environment characteristics				
Degree of protection		Conforming to IEC 60529 and IEC 60947-5-2	IP 67	IP 65
Storage temperature		°C - 40...+ 80	- 10...+ 80	
Operating temperature		°C - 20...+ 65	0...+ 50	
Vibration resistance		Conforming to IEC 60068-2-6	Amplitude ± 1 mm (f = 10...55 Hz)	
Mechanical shock resistance		Conforming to IEC 60068-2-27	30 gn, duration 11 ms, in all 3 axes	
Resistance to electromagnetic interference			Conforming to IEC 60947-5-2	

(1) Silicone face for optimum chemical resistance.

Dimensions

XX518A3●AM12
XXB18A3●AM12
XX918A3●AM12
XX218A3●M12

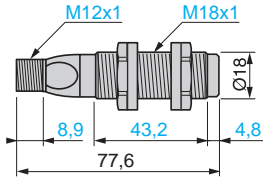

XX630A1●M12
XX630S1●M12
XX630A2●M12
XX930A1A●M12
XX230A1●A00M12
XX230A2●A00M12

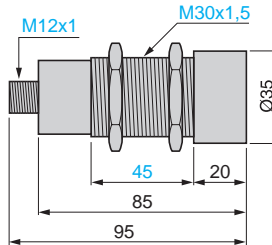

Setting-up precautions

Minimum mounting distances

Diffuse sensors, cylindrical type

Side by side

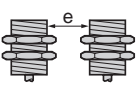

Face to face

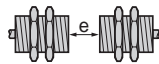

e: respect the distances indicated on the detection curves

$e \geq 4 \times S_n$

Diffuse sensors, flat format

Side by side

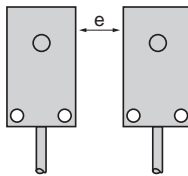

e: respect the distances indicated on the detection curves

XXV18●

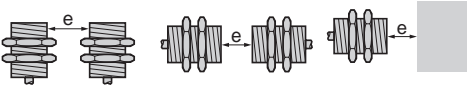

$e > 25 \text{ mm}$

$e > 700 \text{ mm}$

$e > 60 \text{ mm}$

Thru-beam sensors

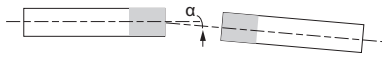

Sensors	α
XX●12●/XX●F1●	$\pm 5^\circ$
XX●18A3●/XX●K1A3●●●	$\pm 8^\circ$
XX●18A4●/XX●K1A4	$\pm 10^\circ$
XX●18A2●/XX●K1A2	

Curves

XX218A3●M12, XX518A3●L2, XXB18A3●AM12, XX518A3●AM12
XX7V1A1●AM12, XXBV1A1●AM12
XX918A3●M12, XX9V1A1●M12

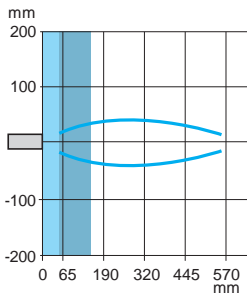

XX230A1●, XX630A1●CM12,
XX6V3A1●AM12, XXBV3A1●AM12, XX930A1●M12, XX9V3A1●M12,
XX8D1A1●AM12, XXBD1A1●AM12

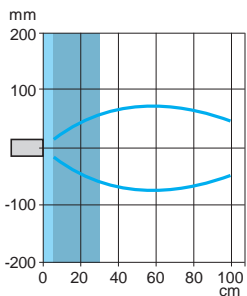

XX230A2●

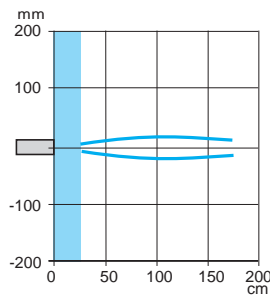

Blind zone for diffuse sensors.

Blind zone for reflex sensors.

Ultrasonic sensors

XX range, General purpose
Flat format, plastic
DC supply, solid-state output



XX7V1A1NAM12



XX7F1A2NAL01M12



XX7K1A2NAM12



XXZPB100

Diffuse system

Fixed sensing distance sensors

Sensors	Sensing distance (Sn)	Function/output	Connection	Reference	Weight
mm	m				kg
7.6 x 19 x 33	0.10	NO/NPN	152 mm flying lead + M12 connector	XX7F1A2NAL01M12	0.040
		NO/PNP	152 mm flying lead + M12 connector	XX7F1A2PAL01M12	0.040
16 x 30 x 74	0.25	NO/NPN	M12 connector	XX7K1A2NAM12	0.050
		NO/PNP	M12 connector	XX7K1A2PAM12	0.050

Adjustable sensing distance sensors

18 x 33 x 60 + Ø 18	0.50 (adjustable)	NO/NPN	M12 connector	XX7V1A1NAM12	0.060
		NO/PNP	M12 connector	XX7V1A1PAM12	0.060
80 x 80 x 34	1 (adjustable)	NO/NPN	M12 connector	XX8D1A1NAM12	0.300
		NO/PNP	M12 connector	XX8D1A1PAM12	0.300

Reflex system

Adjustable sensing distance sensors

Sensors	Sensing distance (Sn)	Function/output	Connection	Reference	Weight
mm	m				kg
18 x 33 x 60 + Ø 18	0.50 (adjustable)	NO/PNP	M12 connector	XXBV1A1PAM12	0.060
80 x 80 x 34	1 (adjustable)	NO/PNP	M12 connector	XXBD1A1PAM12	0.300

Thru-beam system

Sensors	Sensing distance (Sn)	Function/output	Connection	Reference	Weight
mm	m				kg
7.6 x 19 x 33					
Transmitter	0.20	–	152 mm flying lead + M12 connector	XXTF1A8M12L	0.030
Receiver	0.20	NO/PNP + NO/NPN	152 mm flying lead + M12 connector	XXRF1A8KAM12L	0.030
		NC/PNP + NC/NPN	152 mm flying lead + M12 connector	XXRF1A8KBM12L	0.030
16 x 30 x 74					
Transmitter	0.61	–	M12 connector	XXTK1A3M12	0.060
Receiver	0.61	NO/PNP + NO/NPN	M12 connector	XXRK1A3KAM12	0.060
		NC/PNP + NC/NPN	M12 connector	XXRK1A3KBM12	0.060
Transmitter	1	–	M12 connector	XXTK1A4M12	0.060
Receiver	1	NO/PNP + NO/NPN	M12 connector	XXRK1A4KAM12	0.060
		NC/PNP + NC/NPN	M12 connector	XXRK1A4KBM12	0.060

Accessories

Description	For use with sensor	Reference	Weight
			kg
Teach pushbutton Selection of detection window Length of cable: 152 mm Input: M12 female connector Output: M12 male connector	XX7V1A1●AM12, XX8D1A1●AM12, XXBV1A1●AM12 and XXBD1A1●AM12	XXZPB100	0.035

Other connection and fixing accessories

See page 48.

Ultrasonic sensors

XX range, Application

Plastic case, cylindrical type and flat format

Sensors with analogue output signal 0...10 V or 4-20 mA



DF53726

XX9V1A1C2M12



121389

XXZPB100

Flat format sensors

Sensors	Sensing distance (Sn) (adjustable)	Analogue output (Slope selection using teach button)	Reference	Weight
mm	m			kg
18 x 33 x 65 + Ø 18	0.5	4-20 mA	XX9V1A1C2M12	0.090
		0-10 V	XX9V1A1F1M12	0.060
80 x 80 x 34	1	4-20 mA	XX9D1A1C2M12	0.300
		0-10 V	XX9D1A1F1M12	0.300

Accessories

Teach pushbutton

Teach pushbutton	For use with sensors	Reference	Weight kg
Selection of detection window	XX918A●	XXZPB100	0.035
Length of cable: 152 mm	XX9V3A●		
Input: M12 female connector	XX9D1A●		
Output: M12 male connector			

Other connection and fixing accessories

See page 48.

Ultrasonic sensors

XX range, General purpose
Flat format, plastic
DC supply, solid-state output

Sensor type	XX7F●	XXTF● XXRF●	XX7K●	XXTK● XXRK●	XX7V● XXBV1●	XX8D● XXBD●	XX9V1A1●	XX9D1A1●	
General characteristics									
Conformity to standards	CE, IEC 60947-5-2								
Product certifications	UL, cCSAus	UL	cCSAus	UL	UL, cCSAus (1)	UL, cCSAus (1)	UL, cCSAus		
Nominal sensing distance (Sn)	m	0.1	0.2	0.25	0.6 (XX●K1A3) 1 (XX●K1A4)	0.5	1	0.5	1
Blind zone (in diffuse mode the object is not detected in this zone, in reflex mode the background is not detected in this zone)	mm	0...6.4	–	0...51	–	0 ... 51 (XX7V1●) 0 ... 165 (XXBV1●)	0 ... 100 (XX8D●) 0 ... 315 (XXBD●)	0...51	0...100
Detection window		Fixed				Remotely adjustable or by using teach button			
Detection system	Diffuse	●	–	●	–	●	●	–	–
	Reflex	–	–	–	–	●	●	–	–
	Thru-beam	–	●	–	●	–	–	–	–
Transmission frequency	kHz	500	500	500	200	300	180	300	180
Differential travel	mm	< 0.7	–	< 0.35	–	< 2.5	< 2.5	–	–
Repeat accuracy	mm	± 0.7	± 0.79	± 0.7	± 0.79	± 1.27	± 1.6	1.27	± 1.6
Overall beam angle (see detection lobe)		14°	10°	14°	20°	12°	7°	6°	7°
Minimum size of object to be detected		Cylinder Ø 2.5 mm or flat bar 1 mm wide up to 50 mm	Cylinder Ø 12.2 mm at a distance of 200 mm	Cylinder Ø 1.6 mm up to 76 mm	XX●K1A3: Cylinder Ø 38 mm at a sensing distance of 600 mm XX●K1A4: Cylinder Ø 114 mm at a distance of 1 m	Cylinder Ø 2.5 mm or flat bar 1 mm wide for a sensing distance of 150 mm	Cylinder Ø 50 mm up to 1 m	Cylinder Ø 2.5 mm or flat bar 1 mm wide for a sensing distance of 150 mm	Cylinder Ø 50 mm up to a sensing distance of 1 m
Deviation angle from 90° of the object to be detected		–						± 7°	± 5°
Materials	Case	ULTEM®				Valox®			
	Sensing face (2)	Epoxy		Silicone		Epoxy			
Connection	Connector	M12, 4-pin, on 152 mm flying lead		M12, 4-pin					
Supply characteristics									
Rated supply voltage	V	12...24 V $\overline{\text{---}}$							15...24 V $\overline{\text{---}}$
Voltage limits (including ripple)	V	10...28 V $\overline{\text{---}}$							
Current consumption, no-load	mA	25	50	60	XX●K1A3: 60 XX●K1A4: 100	40	70	40	70

(1) Only XX7V● and XX8D● sensors are cCSAus certified.
(2) Silicone face for optimum chemical resistance.

Ultrasonic sensors

XX range, General purpose
Flat format, plastic
DC supply, solid-state output

Sensor type		XX7F●	XXTF● XXRF●	XX7K●	XXTK● XXRK●	XX7V● XXBV1●	XX8D● XXBD●	XX9V1A1●	XX9D1A1●	
Output characteristics										
Slope type		Direct or inverse by using teach button, See page 48.								
LED indicators	Output state	Yellow LED								
	Power on	Green LED			–	Green LED				
	Setting-up assistance	–				Multicolour LED		Dual colour LED		
Delays	First-up	ms	–				100	75		
Recovery time		ms	–				150	180		
Resistive load impedance	4-20 mA	Ω	–				10...500	10...350		
	0-10 V	Ω	–				1 k...∞	2 k fixed		
Switching capacity	(PNP and NPN)	mA	< 100, NO or NC function					100		
Voltage drop	(PNP and NPN)	V	< 1	< 1.1	< 1	< 1	< 1	< 1		
Maximum switching frequency		Hz	100	125	80	125	40	72		
Delays	First-up	ms	20	20	350	200	100	75		
	Response	ms	4	4	5	5	10	15		
	Recovery	ms	4	4	5	5	10	75		
Environment characteristics										
Degree of protection	Conforming to IEC 60529 and IEC 60947-5-2		IP 67							
Storage temperature		°C	- 40...+ 80							
Operating temperature		°C	- 20...+ 65	0...+ 50	- 20...+ 65	- 20...+ 65	0...+ 70	- 20...+ 65	0...+ 70	
Vibration resistance	Conforming to IEC 60068-2-6		Amplitude ± 1 mm (f = 10...55 Hz)							
Mechanical shock resistance	Conforming to IEC 60068-2-27		30 gn, duration 11 ms, in all 3 axes							
Resistance to electromagnetic interference			Conforming to IEC 60947-5-2							

Dimensions

XX7F1A2●AL01M12
XXTF1A8●/XXR F1A8●

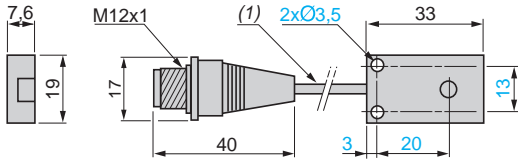

XX7K1A2●AM12
XXTK1A3●/A4●, XXRK1A3●/A4●

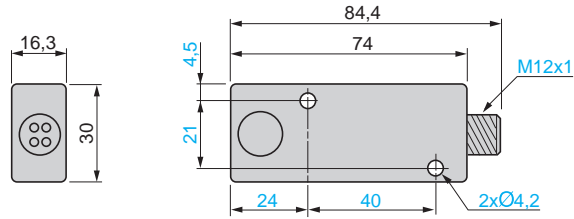

(1) Cable, length: 152 mm.

XX7V1A1●AM12
XXBV1A1●AM12

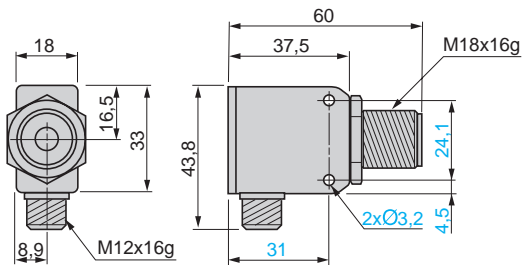

XX9V1A1●M12

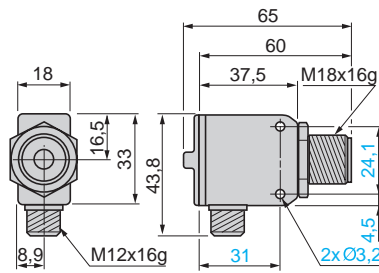

XX8D1A1●AM12
XXBD1A1●AM12
XX9D1A1●●AM12

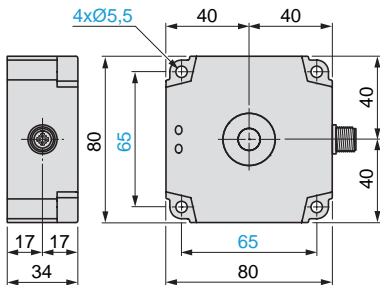

XXZPB100

Teach pushbutton

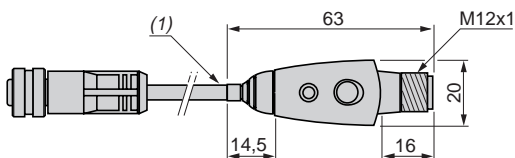

(1) Cable, length: 152 mm.

Setting-up precautions

Minimum mounting distances

Diffuse sensors, cylindrical type

Side by side

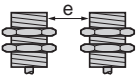

Face to face

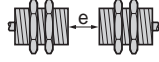

e: respect the distances indicated on the detection curves

$$e \geq 4 \times S_n$$

XXV18●

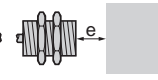
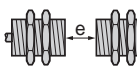
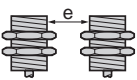

e > 25 mm

e > 700 mm

e > 60 mm

Diffuse sensors, flat format

Side by side

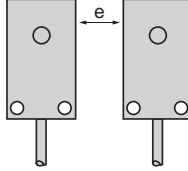

e: respect the distances indicated on the detection curves

Thru-beam sensors

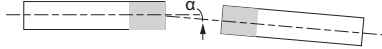

Sensors	α
XX●12●●/XX●F1●●	$\pm 5^\circ$
XX●18A3●●/XX●K1A3●●●●	$\pm 8^\circ$
XX●18A4●●/XX●K1A4	$\pm 10^\circ$
XX●18A2●●/XX●K1A2	

Curves

XX7F1A2● A L01M12

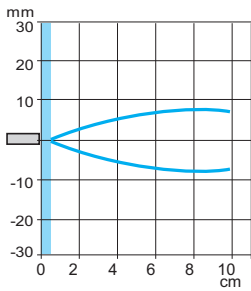

XX7K1A2● AM12

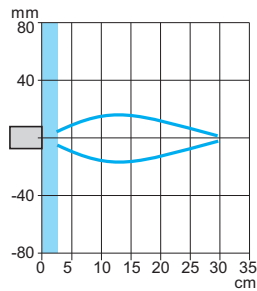

XX218A3●●M12, XX518A3●●L2,
XXB18A3●AM12, XX518A3●AM12
XX7V1A1●AM12, XXBV1A1●AM12
XX918A3●●M12, XX9V1A1●●M12

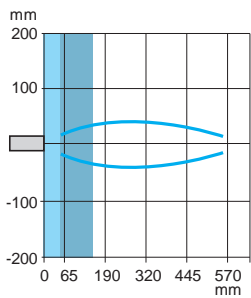

Blind zone for diffuse sensors.

Blind zone for reflex sensors.

Schemes

M12 connector, digital output (XXF●, XXK●)

3-wire type

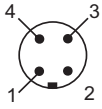

- 1 (+)
- 3 (-)
- 4 NPN or PNP output

**XX7F1A2NAL01M12 (1),
XX7K1A2NAM12**

NO outputs, NPN

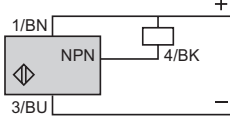

XX7F1A2PAL01M12 (1), XX7K1A2PAM12,

NO outputs, PNP

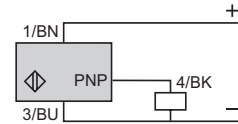

- (-) BU (Blue)
- (+) BN (Brown)
- BK (Black)

(1) Remote connector on flying lead approximately 15 cm long.

M12 connector, analogue output

XX930A●/XX930S●

XX918A●/XX9V1A●/XX9V3A●/XX9D1●

4-wire type

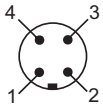

- 1 (+)
- 2 Return signal or teach
- 3 (-)
- 4 Output signal

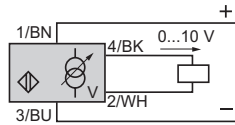

- BN (Brown)
- WH (White)
- BU (Blue)
- BK (Black)

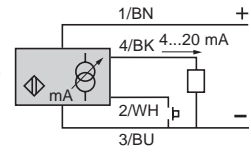
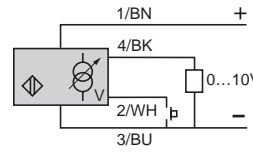
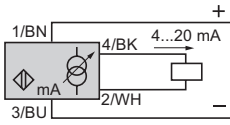

For impedance of resistive load refer to values on page 47.

Ultrasonic sensors

XX range, General purpose

Cylindrical, plastic or metal, Ø 30 mm

Diffuse system, solid-state digital or analog output

Configurable by software



XXA30P1PM12
XXS30P1PM12



XXS30B2PM12
XXA30S2PM12



XXS30S4PM12



XXS30P1AM12

XXS30P2AM12

Ultrasonic sensors

Sensors with solid-state digital output, M12 connector

Sensors	Sensing distance (Sn) m	Function/output	Axis	Reference	Weight kg
Ø 30 Plastic	1	NO or NC (1)/PNP	Straight	XXS30P1PM12	0.047
			90° angled	XXA30P1PM12	0.100
	2		Straight	XXS30P2PM12	0.095
			90° angled	XXA30P2PM12	0.100
Ø 30 Nickel-plated brass	1	NO or NC (1)/PNP	Straight	XXS30B1PM12	0.165
			90° angled	XXA30B1PM12	0.175
	2		Straight	XXS30B2PM12	0.165
			90° angled	XXA30B2PM12	0.175
Ø 30 Stainless steel 316L	1	NO or NC (1)/PNP	Straight	XXS30S1PM12	0.160
			90° angled	XXA30S1PM12	0.170
	2		Straight	XXS30S2PM12	0.160
			90° angled	XXA30S2PM12	0.170
4		Straight	XXS30S4PM12	0.190	

Adjustable sensing distance sensors

Sensors	Sensing distance (Sn) m	Function/output	Connection	Reference	Weight kg
Ø 30 Plastic	1	4-20 mA	Straight	XXS30P1AM12	0.047
			Straight	XXS30P1VM12	0.047
	90° angled	4-20 mA	Straight	XXA30P1AM12	0.100
			Straight	XXA30P1VM12	0.100
	2	4-20 mA	Straight	XXS30P2AM12	0.095
			Straight	XXS30P2VM12	0.095
90° angled	4-20 mA	Straight	XXA30P2AM12	0.100	
		Straight	XXA30P2VM12	0.100	
4	4-20 mA	Straight	XXS30P4AM12	0.115	
		Straight	XXS30P4VM12	0.115	

Ultrasonic sensors

XX range, General purpose
 Cylindrical, plastic or metal, Ø 30 mm
 Diffuse system, solid-state digital or analog output
 Configurable by software



XXS30B1AM12
 XXA30B1AM12



XXS30S2AM12
 XXA30B2AM12



XXS30B4AM12 XXS30S1AM12



XXZPB100

Ultrasonic sensors (continued)

Adjustable sensing distance sensors

Sensors	Sensing distance (Sn) m	Function/ output	Connection	Reference	Weight kg
Ø 30 Nickel-plated brass	1	4-20 mA	Straight	XXS30B1AM12	0.165
		0-10 V	Straight	XXS30B1VM12	0.165
		4-20 mA	90° angled	XXA30B1AM12	0.175
		0-10 V	90° angled	XXA30B1VM12	0.175
	2	4-20 mA	Straight	XXS30B2AM12	0.165
		0-10 V	Straight	XXS30B2VM12	0.165
		4-20 mA	90° angled	XXA30B2AM12	0.175
		0-10 V	90° angled	XXA30B2VM12	0.175
4	4-20 mA	Straight	XXS30B4AM12	0.195	
	0-10 V	Straight	XXS30B4VM12	0.195	
	4-20 mA	Straight	XXS30S1AM12	0.160	
	0-10 V	Straight	XXS30S1VM12	0.160	
Ø 30 Stainless steel 316L	1	4-20 mA	Straight	XXS30S1AM12	0.160
		0-10 V	Straight	XXS30S1VM12	0.160
		4-20 mA	90° angled	XXA30S1AM12	0.170
		0-10 V	90° angled	XXA30S1VM12	0.170
	2	4-20 mA	Straight	XXS30S2AM12	0.160
		0-10 V	Straight	XXS30S2VM12	0.160
		4-20 mA	90° angled	XXA30S2AM12	0.170
		0-10 V	90° angled	XXA30S2VM12	0.170
4	4-20 mA	Straight	XXS30S4AM12	0.190	
	0-10 V	Straight	XXS30S4VM12	0.190	

Accessories

Description	For use with sensor	Reference	Weight kg
Teach pushbutton	XXS30●●	XXZPB100	0.035
Input: M12 female connector Output: M12 male connector	XXA30●●		

Configuration interface and kit for the synchronization function

See page 57

Ultrasonic sensors

XX range, General purpose

Cylindrical, plastic or metal, Ø 30 mm

Diffuse system, solid-state digital or analog output

Configurable by software



PF121334

XZCPV11V12L2



PF111910

XZCPV12V12L2



DF100520

XZCP1141L10



PF152522A

XZCC12FDM50B



PF152522A

XXZB130

Accessories (continued)

Description	Type	Length	Reference	Weight kg
Pre-wired connector 5-pin, 5-wire female M12 connector/bare wires PVC cable	Straight	2	XZCPV11V12L2	0.090
		5	XZCPV11V12L5	0.201
		10	XZCPV11V12L10	0.360
	Elbowed	2	XZCPV12V12L2	0.090
		5	XZCPV12V12L5	0.201
		10	XZCPV12V12L10	0.360

Connection accessories without synchronization function

Pre-wired connector 5-pin, 5-wire female M12 connector/bare wires PVC cable	Straight	2	XZCP1141L2	0.090
		5	XZCP1141L5	0.190
		10	XZCP1141L10	0.370
	Elbowed	2	XZCP1241L2	0.090
		5	XZCP1241L5	0.201
		10	XZCP1241L10	0.360
Female M12 connector 5-pin, Pg 7 cable gland	Straight	–	XZCC12FDM50B	0.020
			XZCC12FDM50B	0.020

Mounting accessory

Description	For use with sensor	Weight kg
Fixing clamp (1)	XXS30●● XXA30●●	XXZB130 0.010

Configuration interface and kit for the synchronization function

See page 57

(1) Output function (NO or NC) and mode (window, reflex, proximity, pump) are selectable using the **XXZPB100** remote

(2) Selectable using the **XXZPB100** remote teach pushbutton.

Ultrasonic sensors

XX range, General purpose

Cylindrical, plastic or metal, Ø 30 mm

Diffuse system, solid-state digital or analog output

Configurable by software

Sensor type		XXS30P1PM12	XXS30P1AM12	XXS30P1VM12
General characteristics				
Conformity to standards		EN/IEC 60947-5-2, UL 508, and CSA C22.2 n°14		
Compliance with regulations		CE (based on EMC directive 2014/30/EU), NEC (ANSI/NFPA 70), CEC (CSA C22), UNECE R10		
Product certifications		cULus with class 2 power supply, E2, EAC, RCM, and ECOLAB		
Nominal sensing distance (Sn)		m 1 (adjustable)		
Blind zone (in diffuse mode the object is not detected in this zone)		m 0.105		
Detection window		Remotely adjustable or by using external teachbutton XXZPB100		
Transmission frequency (transmitter resonance)		kHz 200		
Differential travel		mm < 5	–	–
Repeat accuracy (repeatability)		0.1 %		
Minimum size of object to be detected		Cylinder Ø 1 mm up to sensing distance of 0.6m		
Tilt angle with 100 x 100 mm target		± 7° at 1 m, ± 10° at 0.9 m ± 35° at 0.5 m		
Materials		XX●30P●: PBT		
Case		Epoxy, resin, and rubber		
Sensing face				
Connection		M12 connector - 5-pin		
Supply characteristics				
Rated supply voltage (Ue) with protection against reverse polarity		V 12...24 V $\overline{\text{---}}$	12...24 V $\overline{\text{---}}$	24 V $\overline{\text{---}}$
Voltage limits (including ripple)		V 10...30 V $\overline{\text{---}}$	10...30 V $\overline{\text{---}}$	14...30 V $\overline{\text{---}}$
Current consumption, no-load		mA < 30	< 30	< 30
Output characteristics				
LED indicators				
Output state		Yellow LED	Yellow LED	Yellow LED
Echo state		Green LED	Green LED	Green LED
Switching capacity (with overload and short-circuit protection)		< 100 mA	–	–
Resistive load impedance		Ω –	12 V $\overline{\text{---}}$ load \leq 250 Ω 24 V $\overline{\text{---}}$ load \leq 850 Ω	\geq 1 kΩ
Voltage drop		V < 2	–	–
Internal temperature compensation		Yes	Yes	Yes
Maximum switching frequency		Hz 11	–	–
Delays				
First-up		ms 120	180	180
Response		ms 45	–	–
Recovery		ms 45	100	100
Environment characteristics				
Degree of protection		Conforming to IEC 60529 and EN/IEC 60947-5-2 IP 65, IP 67		
Storage temperature		°C - 40...+ 80		
Operating temperature		°C - 25...+ 70		
Relative humidity		< 95%, without condensation		
Vibration resistance		Conforming to IEC 60068-2-6 Amplitude \pm 1 mm (f = 10...55 Hz)		
Mechanical shock resistance		Conforming to IEC 60068-2-27 30 gn, duration 11 ms, in all 3 axes		
Resistance to electromagnetic interference		Conforming to EN/IEC 60947-5-2 and UNECE R10-05		

Ultrasonic sensors

XX range, General purpose

Cylindrical, plastic or metal, Ø 30 mm

Diffuse system, solid-state digital or analog output

Configurable by software

Sensor type	XXA30P1PM12 XX●30B1PM12 XX●30S1PM12	XXA30P1AM12 XX●30B1AM12 XX●30S1AM12	XXA30P1VM12 XX●30B1VM12 XX●30S1VM12
General characteristics			
Conformity to standards	EN/IEC 60947-5-2, UL 508, and CSA C22.2 n°14		
Compliance with regulations	CE (based on EMC directive 2014/30/EU), NEC (ANSI/NFPA 70), CEC (CSA C22), UNECE R10		
Product certifications	cULus with class 2 power supply, E2, EAC, RCM, and ECOLAB		
Nominal sensing distance (Sn)	m	1 (adjustable)	
Blind zone (in diffuse mode the object is not detected in this zone)	m	0.155	
Detection window	Remotely adjustable or by using external teachbutton XXZPB100		
Transmission frequency (transmitter resonance)	kHz	120	
Differential travel	mm	< 5	-
Repeat accuracy (repeatability)	0.1 %		
Minimum size of object to be detected	Cylinder Ø 1 mm up to sensing distance of 1m		
Tilt angle with 100 x 100 mm target	± 12° at 1 m, ± 15° at 0.9 m ± 45° at 0.5 m		
Materials	Case	XX●30P●: PBT XX●30B●: Nickel-plated brass XX●30S●: Stainless steel 316L	
	Sensing face	Epoxy, resin, and rubber	
Connection	M12 connector - 5-pin		
Supply characteristics			
Rated supply voltage (Ue) with protection against reverse polarity	V	12...24 V $\overline{\text{---}}$	12...24 V $\overline{\text{---}}$
Voltage limits (including ripple)	V	10...30 V $\overline{\text{---}}$	10...30 V $\overline{\text{---}}$
Current consumption, no-load	mA	< 65	< 65
Output characteristics			
LED indicators	Output state	Yellow LED	Yellow LED
	Echo state	Green LED	Green LED
Switching capacity (with overload and short-circuit protection)		< 100 mA	-
Resistive load impedance	Ω	-	12 V $\overline{\text{---}}$ load \leq 250 Ω 24 V $\overline{\text{---}}$ load \leq 850 Ω
Voltage drop	V	< 2	-
Internal temperature compensation		Yes	Yes
Maximum switching frequency	Hz	11	
Delays	First-up	ms	120
	Response	ms	45
	Recovery	ms	45
Environment characteristics			
Degree of protection Conforming to IEC 60529 and EN/IEC 60947-5-2		IP 65, IP 67	
Storage temperature	°C	- 40...+ 80	
Operating temperature	°C	- 25...+ 70	
Relative humidity		< 95%, without condensation	
Vibration resistance Conforming to IEC 60068-2-6		Amplitude \pm 1 mm (f = 10...55 Hz)	
Mechanical shock resistance Conforming to IEC 60068-2-27		30 gn, duration 11 ms, in all 3 axes	
Resistance to electromagnetic interference		Conforming to EN/IEC 60947-5-2 and UNECE R10-05	

Ultrasonic sensors

XX range, General purpose

Cylindrical, plastic or metal, Ø 30 mm

Diffuse system, solid-state digital or analog output

Configurable by software

Operating diagrams for digital output sensors

Settings with teach procedure

Window mode

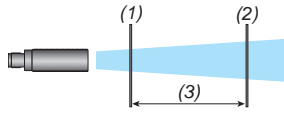

- (1): Near limit
- (2): Far limit
- (3): Sensing window

Reflex mode

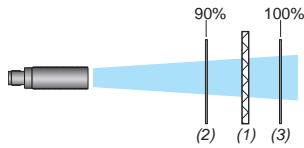

- (1): Reflector
- (2): Near limit
- (3): Far limit

Proximity mode

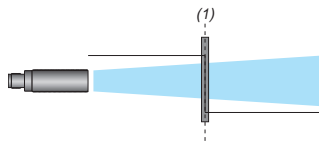

- (1) Switch point

Pump/Hysteresis mode

Emptying (stored in high threshold memory)

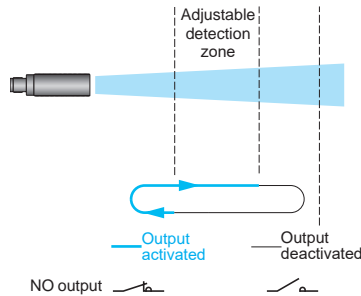

Filling (stored in low threshold memory)

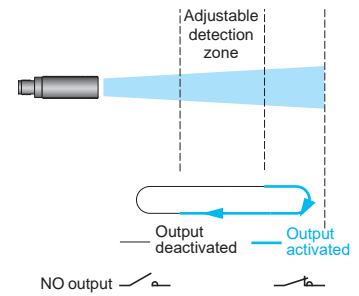

Ultrasonic sensors

XX range, General purpose

Cylindrical, plastic or metal, Ø 30 mm

Diffuse system, solid-state digital or analog output

Configurable by software

Operating diagram for analog output sensors

Near and far limits setting with teach procedure

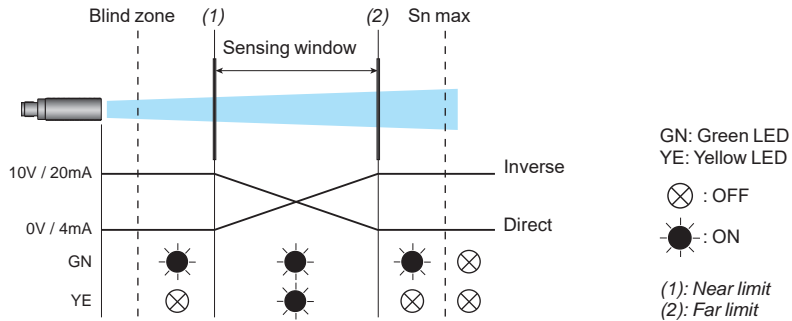
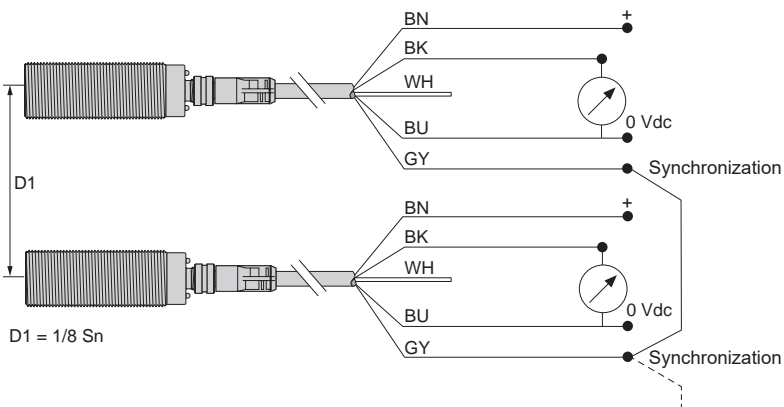

Diagram for the synchronization function (side by side application)



NB: To enable synchronization between several sensors, all of the wires of pin no.5 (gray) must be electrically connected together. A maximum of 8 sensors can be synchronized. To enable "Multiplexer" function for the sensors, use the XX Configuration Software. Without synchronization or multiplexing, the sensors must be at least 50 cm away from each other in order to avoid mutual interference.

Ultrasonic sensors

XX range, General purpose
Cylindrical, plastic or metal, Ø 30 mm
Diffuse system, solid-state digital or analog output
Configurable by software

Dimensions

XXA30B1●M12
XXA30S1●M12
XXA30P1●M12

XXS30B1●M12
XXS30S1●M12

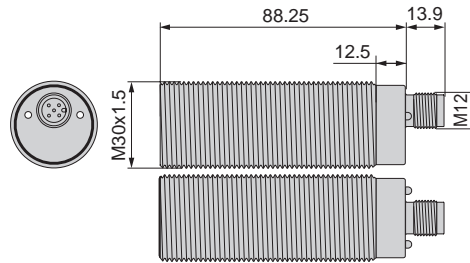
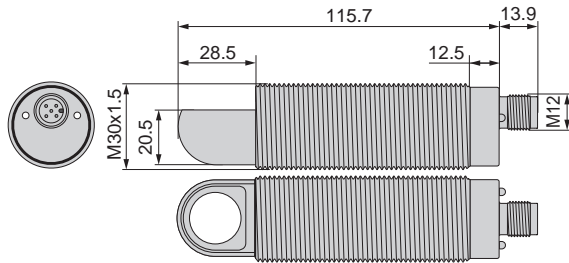

Connections

Connector wiring

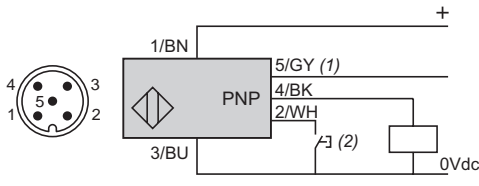

Pin number	Wire color	Digital output description	Analog output description	
			4-20 mA	0-10 V
1	BN: Brown	+12...24 V $\overline{\text{---}}$	+12...24 V $\overline{\text{---}}$	+14...24 V $\overline{\text{---}}$
2	WH: White	Input teach		
3	BU: Blue	0 V $\overline{\text{---}}$		
4	BK: Black	Output		
5	GY: Gray	Synchronization		

(1) Synchronization.

(2) External setting pushbutton or XXZPB100 remote teach pushbutton (see page 59).

Wiring scheme (digital output NO or NC)

XXA30●PM12/XXS30●PM12

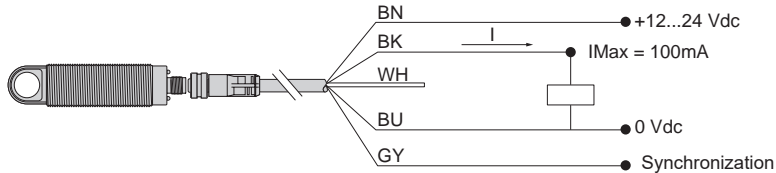

Wiring scheme (analog output 0-10V)

XX●30●VM12

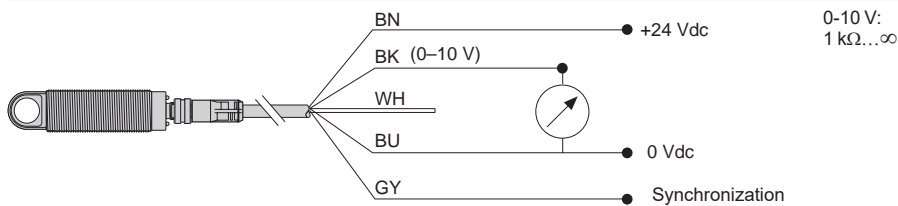

Wiring scheme (analog output 4-20 mA)

XX●30●AM12

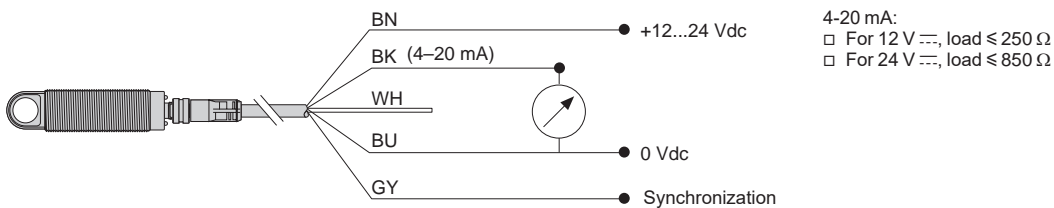

Ultrasonic sensors

XX range, General purpose

Cylindrical, plastic or metal, Ø 30 mm

Diffuse system, solid-state digital or analog output

Configurable by software

Dimensions (continued)

Fixing clamp XXZB130

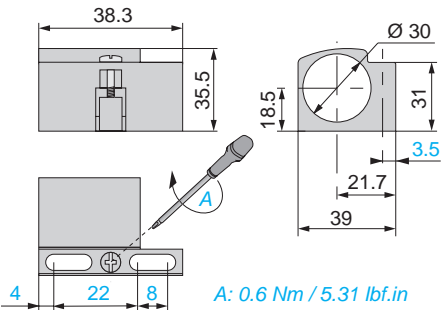

Teach pushbutton XXZPB100

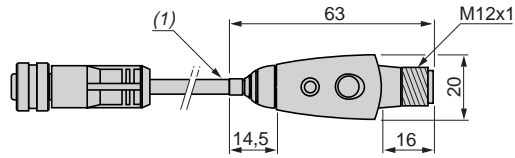

(1) Cable length: 152 mm

Curves

Detection curve with 100 x 100 mm square target

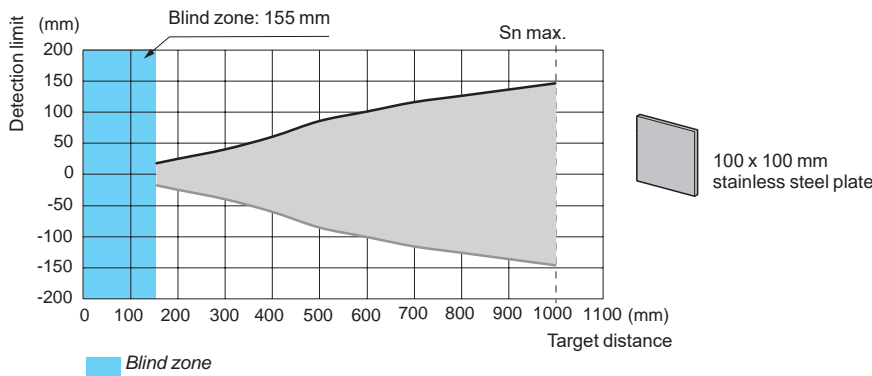

Detection curve with round bar

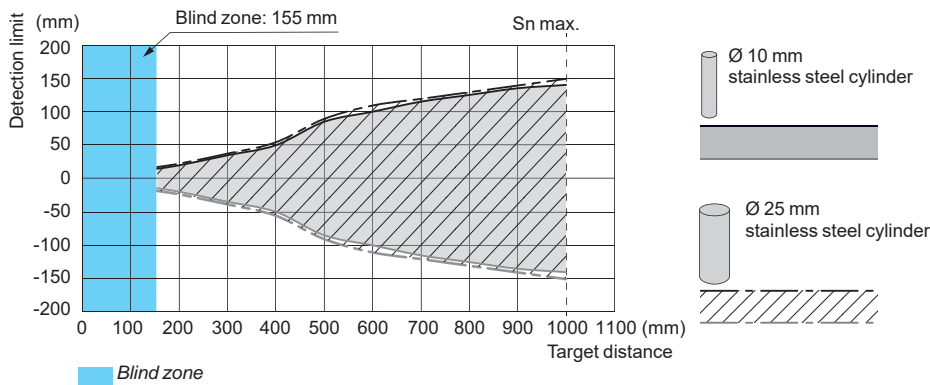

Ultrasonic sensors

XX range, General purpose
Cylindrical, plastic or metal, Ø 30 mm
Diffuse system, solid-state digital or analog output
Configurable by software

Dimensions

XXS30P1PM12
XXS30P1AM12
XXS30P1VM12

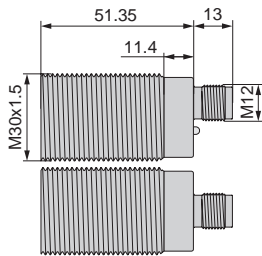

Connections

Connector wiring

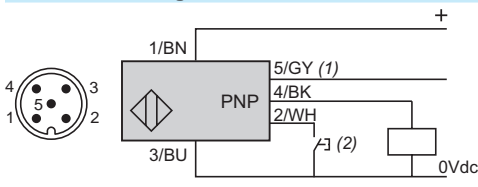

Pin number	Wire color	Digital output description	Analog output description	
			4-20 mA	0-10 V
1	BN: Brown	+12...24 V \square	+12...24 V \square	+14...24 V \square
2	WH: White	Input teach		
3	BU: Blue	0 V \square		
4	BK: Black	Output		
5	GY: Gray	Synchronization		

- (1) Synchronization.
- (2) External setting pushbutton or **XXZPB100** remote teach pushbutton (see page 61).

Wiring scheme (digital output NO or NC)

XXS30●●PM12

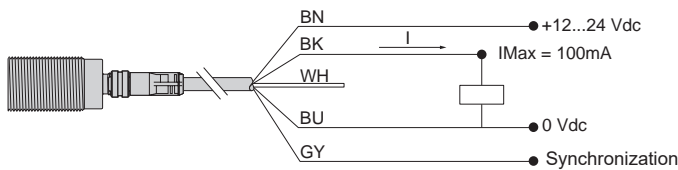

Wiring scheme (analog output 0-10V)

XX●30●●VM12

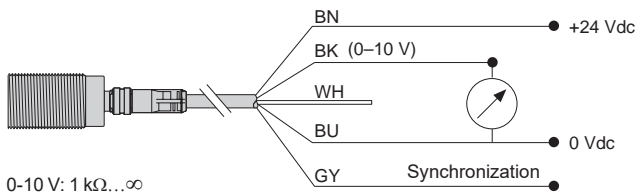

Wiring scheme (analog output 4-20 mA)

XX●30●●AM12

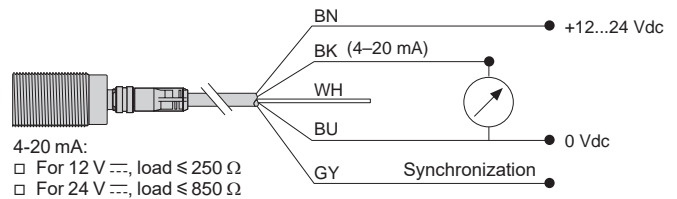
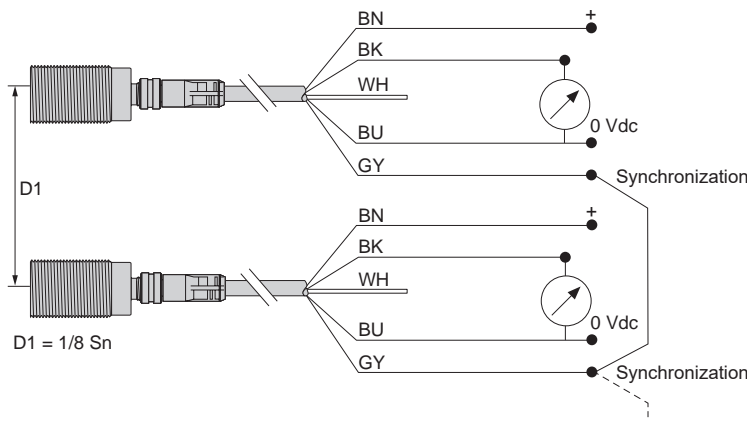

Diagram for the synchronization function (Side by side application)



NB: To enable synchronization between several sensors, all of the wires of pin no.5 (gray) must be electrically connected together. A maximum of 8 sensors can be synchronized. To enable "Multiplexer" function for the sensors, use the XX Configuration Software. Without synchronization or multiplexing, the sensors must be at least 50 cm away from each other in order to avoid mutual interference.

Ultrasonic sensors

XX range, General purpose

Cylindrical, plastic or metal, Ø 30 mm

Diffuse system, solid-state digital or analog output

Configurable by software

Dimensions (continued)

Fixing clamp XXZB130

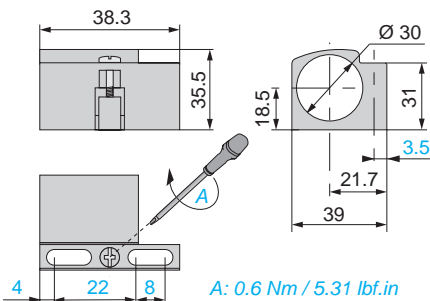

Teach pushbutton XXZPB100

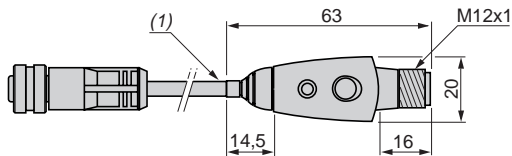

(1) Cable length: 152 mm

Curves

Detection curve with 100 x 100 mm square target

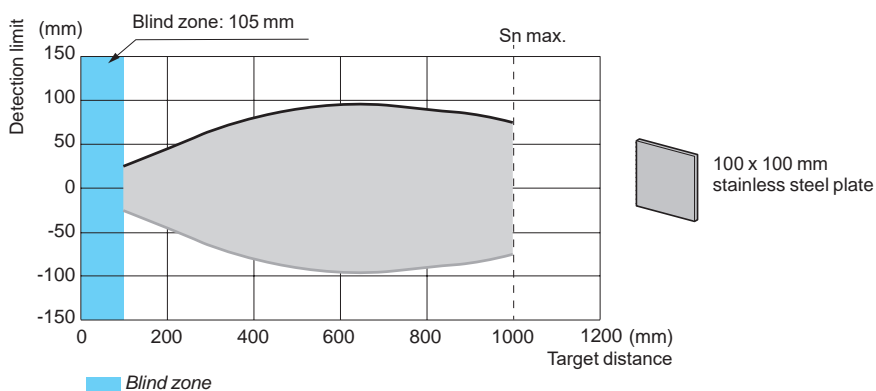

Detection curve with round bar

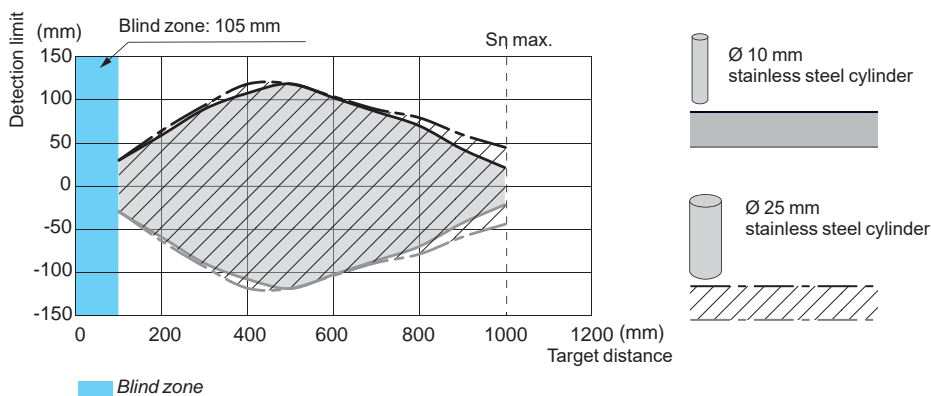

Ultrasonic sensors

XX range, General purpose

Cylindrical, plastic or metal, Ø 30 mm

Diffuse system, solid-state digital or analog output

Configurable by software

Sensor type		XX●30P2PM12 XX●30B2PM12 XX●30S2PM12	XX●30P2AM12 XX●30B2AM12 XX●30S2AM12	XX●30P2VM12 XX●30B2VM12 XX●30S2VM12
General characteristics				
Conformity to standards		EN/IEC 60947-5-2, UL 508, and CSA C22.2 n°14		
Compliance with regulations		CE (based on EMC directive 2014/30/EU), NEC (ANSI/NFPA 70), CEC (CSA C22), UNECE R10		
Product certifications		cULus with class 2 power supply, E2, EAC, RCM, and ECOLAB		
Nominal sensing distance (Sn)		m	2 (adjustable)	
Blind zone (in diffuse mode the object is not detected in this zone)		m	0.155	
Detection window		Remotely adjustable or by using external teachbutton XXZPB100		
Transmission frequency (transmitter resonance)		kHz	120	
Differential travel		mm	< 10	–
Repeat accuracy (repeatability)		0.1 %		
Minimum size of object to be detected		Cylinder Ø 1 mm up to sensing distance of 1.4m		
Tilt angle with 100 x 100 mm target		± 10° at 2 m, ± 12° at 1.8 m ± 45° at 1m		
Materials		XX●30P●: PBT XX●30B●: Nickel-plated brass XX●30S●: Stainless steel 316L		
Case		Epoxy, resin, and rubber		
Sensing face		M12 connector - 5-pin		
Connection		M12 connector - 5-pin		
Supply characteristics				
Rated supply voltage (Ue) with protection against reverse polarity		V	12...24 V $\overline{\text{DC}}$	12...24 V $\overline{\text{DC}}$
Voltage limits (including ripple)		V	10...30 V $\overline{\text{DC}}$	10...30 V $\overline{\text{DC}}$
Current consumption, no-load		mA	< 65	< 65
Output characteristics				
LED indicators		Output state		
		Yellow LED		
		Green LED		
		Echo state		
		Green LED		
		Green LED		
Switching capacity (with overload and short-circuit protection)		< 100 mA		
Resistive load impedance		Ω	–	12 V $\overline{\text{DC}}$ load ≤ 250 Ω 24 V $\overline{\text{DC}}$ load ≤ 850 Ω
Voltage drop		V	< 2	–
Internal temperature compensation		Yes		
Maximum switching frequency		Hz	5.5	Yes
Delays		First-up		
		ms	150	250
		ms	90	–
		ms	90	200
		ms	90	200
Environment characteristics				
Degree of protection		Conforming to IEC 60529 and EN/IEC 60947-5-2		
		IP 65, IP 67		
Storage temperature		°C	- 40...+ 80	
Operating temperature		°C	- 25...+ 70 (1)	
Relative humidity		< 95%, without condensation		
Vibration resistance		Conforming to IEC 60068-2-6		
		Amplitude ± 1 mm (f = 10...55 Hz)		
Mechanical shock resistance		Conforming to IEC 60068-2-27		
		30 gn, duration 11 ms, in all 3 axes		
Resistance to electromagnetic interference		Conforming to EN/IEC 60947-5-2 and UNECE R10-05		

Ultrasonic sensors

XX range, General purpose

Cylindrical, plastic or metal, Ø 30 mm

Diffuse system, solid-state digital or analog output

Configurable by software

Operating diagrams for digital output sensors

Settings with teach procedure

Window mode

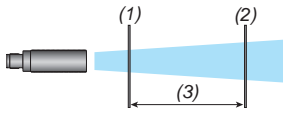

- (1): Near limit
- (2): Far limit
- (3): Sensing window

Reflex mode

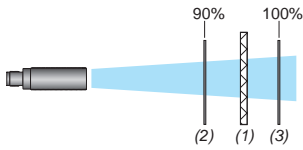

- (1): Reflector
- (2): Near limit
- (3): Far limit

Proximity mode

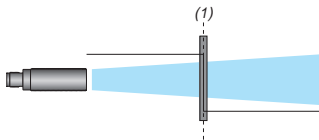

- (1) Switch point

Pump/Hysteresis mode

Emptying (stored in high threshold memory)

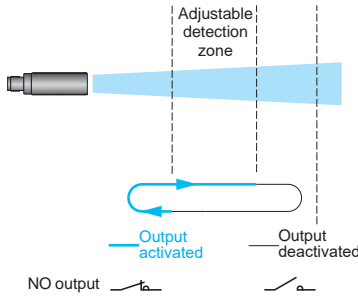

Filling (stored in low threshold memory)

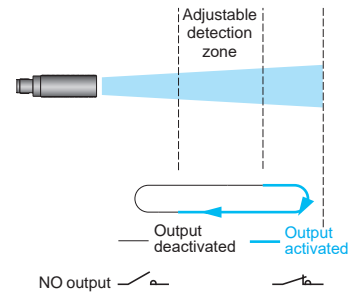

Operating diagram for analog output sensors

Near and far limits setting with teach procedure

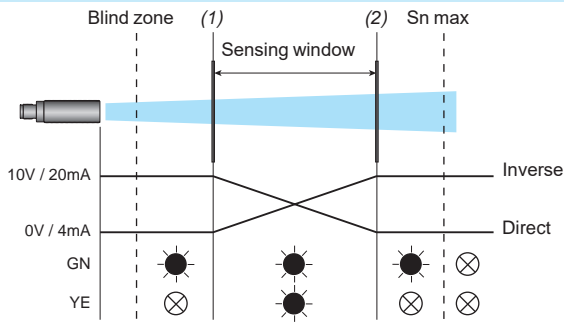

GN: Green LED
YE: Yellow LED

⊗ : OFF

● : ON

(1): Near limit

(2): Far limit

Ultrasonic sensors

XX range, General purpose

Cylindrical, plastic or metal, Ø 30 mm

Diffuse system, solid-state digital or analog output

Configurable by software

Dimensions

XX●30P2PM12
XX●30B2PM12
XX●30S2PM12

XX●30P2AM12
XX●30B2AM12
XX●30S2AM12

XX●30P2VM12
XX●30B2VM12
XX●30S2VM12

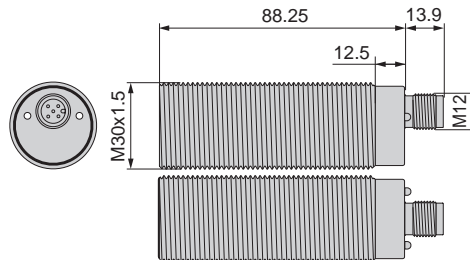
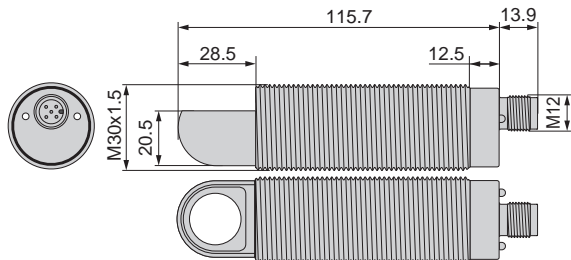

Connections

Connector wiring

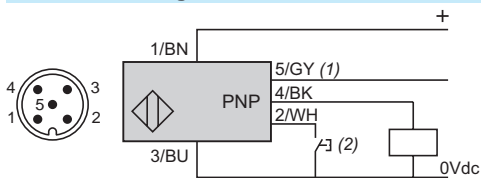

Pin number	Wire color	Digital output description	Analog output description	
			4-20 mA	0-10 V
1	BN: Brown	+12...24 V $\overline{\text{---}}$	+12...24 V $\overline{\text{---}}$	+14...24 V $\overline{\text{---}}$
2	WH: White	Input teach		
3	BU: Blue	0 V $\overline{\text{---}}$		
4	BK: Black	Output		
5	GY: Gray	Synchronization		

(1) Synchronization.

(2) External setting pushbutton or XXZPB100 remote teach pushbutton (see page 65).

Wiring scheme (digital output NO or NC)

XXS30●●PM12 and XXA30●●PM12

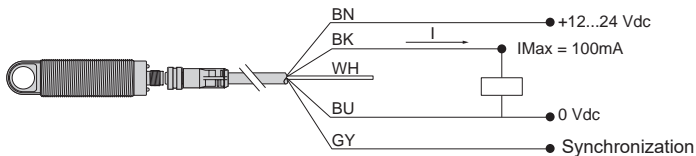

Wiring scheme (analog output 0-10V)

XX●30●●VM12

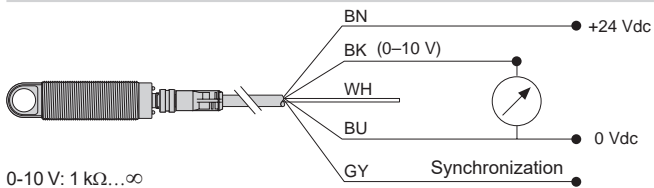

Wiring scheme (analog output 4-20 mA)

XX●30●●AM12

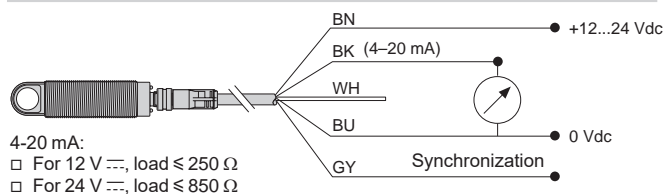
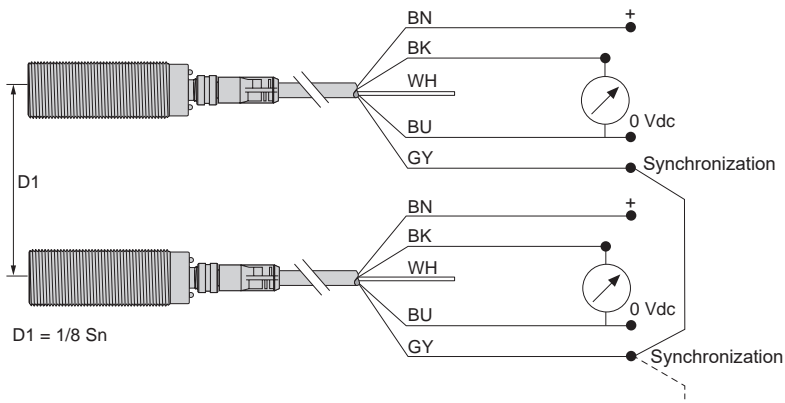

Diagram for the synchronization function (Side by side application)



NB: To enable synchronization between several sensors, all of the wires of pin no.5 (gray) must be electrically connected together. A maximum of 8 sensors can be synchronized. To enable "Multiplexer" function for the sensors, use the XX Configuration Software. Without synchronization or multiplexing, the sensors must be at least 50 cm away from each other in order to avoid mutual interference.

Ultrasonic sensors

XX range, General purpose

Cylindrical, plastic or metal, Ø 30 mm

Diffuse system, solid-state digital or analog output

Configurable by software

Dimensions (continued)

Fixing clamp XXZB130

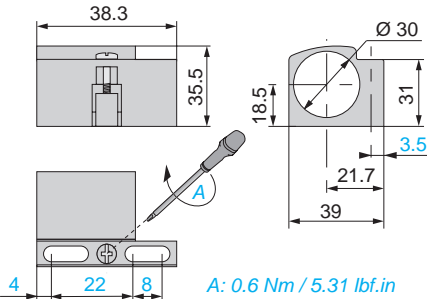

Teach pushbutton XXZPB100

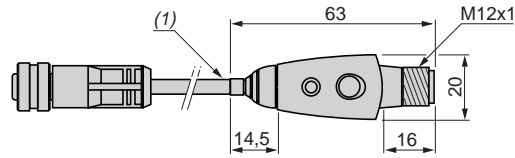

(1) Cable length: 152 mm

Curves

Detection curve with 100 x 100 mm square target

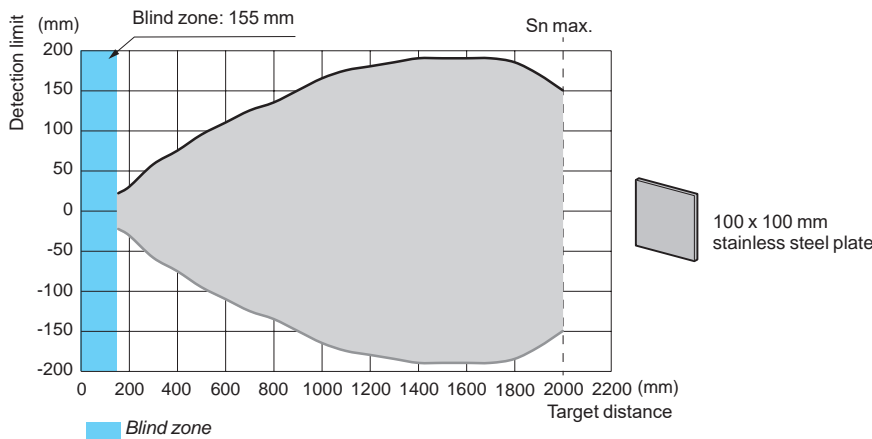

Detection curve with round bar

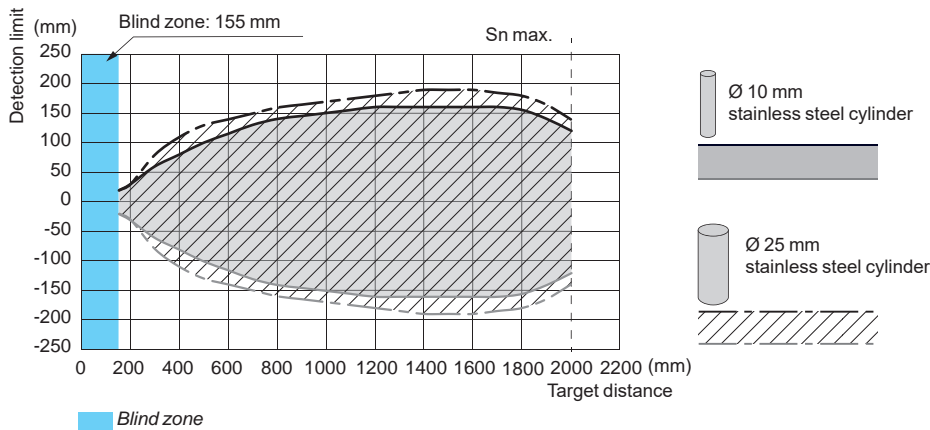

Ultrasonic sensors

XX range, General purpose

Cylindrical, plastic or metal, Ø 30 mm

Diffuse system, solid-state digital or analog output

Configurable by software

Sensor type		XXS30●4PM12	XXS30●4AM12	XXS30●4VM12	
General characteristics					
Conformity to standards		EN/IEC 60947-5-2, UL 508, and CSA C22.2 n°14			
Compliance with regulations		CE (based on EMC directive 2014/30/EU), NEC (ANSI/NFPA 70), CEC (CSA C22), UNECE R10			
Product certifications		cULus with class 2 power supply, E2, EAC, RCM, and ECOLAB			
Nominal sensing distance (Sn)		m	4 (adjustable)		
Blind zone (in diffuse mode the object is not detected in this zone)		m	0.420		
Detection window		Remotely adjustable or by using external teachbutton XXZPB100			
Transmission frequency (transmitter resonance)		kHz	80		
Differential travel		mm	< 20	–	
Repeat accuracy (repeatability)		0.1 %			
Minimum size of object to be detected		Cylinder Ø 1 mm up to sensing distance of 1.8m			
Tilt angle with 500 x 500 mm target		± 7° at 4 m, ± 10° at 3.6 m ± 40° at 2 m			
Materials		Case	XXS30P●: PBT XXS30B●: Nickel-plated brass XXS30S●: Stainless steel 316L		
		Sensing face	Epoxy, resin, and rubber		
Connection		M12 connector - 5-pin			
Supply characteristics					
Rated supply voltage (Ue) with protection against reverse polarity		V	12...24 V $\overline{\text{---}}$	12...24 V $\overline{\text{---}}$	24 V $\overline{\text{---}}$
Voltage limits (including ripple)		V	10...30 V $\overline{\text{---}}$	10...30 V $\overline{\text{---}}$	14...30 V $\overline{\text{---}}$
Current consumption, no-load		mA	< 65	< 65	< 65
Output characteristics					
LED indicators		Output state	Yellow LED	Yellow LED	Yellow LED
		Echo state	Green LED	Green LED	Green LED
Switching capacity (with overload and short-circuit protection)		< 100 mA			–
Resistive load impedance		Ω	–	12 V $\overline{\text{---}}$ load ≤ 250 Ω 24 V $\overline{\text{---}}$ load ≤ 850 Ω	≥ 1 kΩ
Voltage drop		V	< 2	–	–
Internal temperature compensation		Yes			Yes
Maximum switching frequency		Hz	2.7	–	–
Delays		First-up	ms	250	500
		Response	ms	180	–
		Recovery	ms	180	400
Environment characteristics					
Degree of protection		Conforming to IEC 60529 and EN/IEC 60947-5-2	IP 65, IP 67		
Storage temperature		°C	- 40...+ 80		
Operating temperature		°C	- 25...+ 70 (1)		
Relative humidity		< 95%, without condensation			
Vibration resistance		Conforming to IEC 60068-2-6	Amplitude ± 1 mm (f = 10...55 Hz)		
Mechanical shock resistance		Conforming to IEC 60068-2-27	30 gn, duration 11 ms, in all 3 axes		
Resistance to electromagnetic interference		Conforming to EN/IEC 60947-5-2 and UNECE R10-05			

Ultrasonic sensors

XX range, General purpose

Cylindrical, plastic or metal, Ø 30 mm

Diffuse system, solid-state digital or analog output

Configurable by software

Operating diagrams for digital output sensors

Settings with teach procedure

Window mode

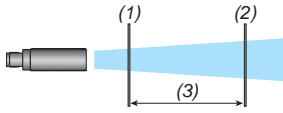

- (1): Near limit
- (2): Far limit
- (3): Sensing window

Reflex mode

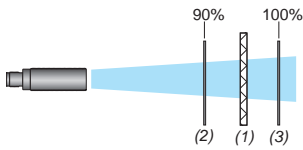

- (1): Reflector
- (2): Near limit
- (3): Far limit

Proximity mode

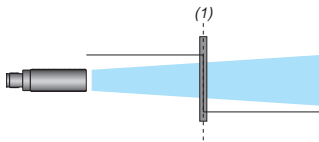

- (1): Switch point

Pump/Hysteresis mode

Emptying (stored in high threshold memory)

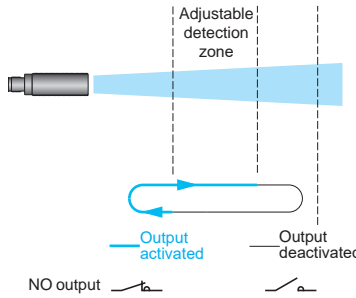

Filling (stored in low threshold memory)

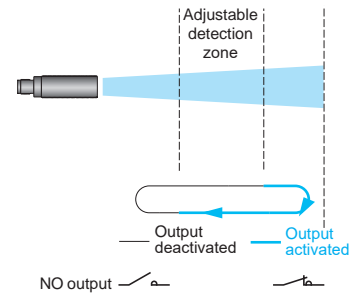

Operating diagram for analog output sensors

Near and far limits setting with teach procedure

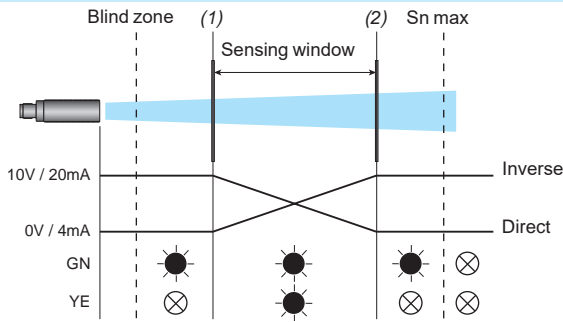

Ultrasonic sensors

XX range, General purpose

Cylindrical, plastic or metal, Ø 30 mm

Diffuse system, solid-state digital or analog output

Configurable by software

Dimensions

XXS30P4PM12
XXS30B4PM12
XXS30S4PM12

XXS30P4AM12
XXS30B4AM12
XXS30S4AM12

XXS30P4VM12
XXS30B4VM12
XXS30S4VM12

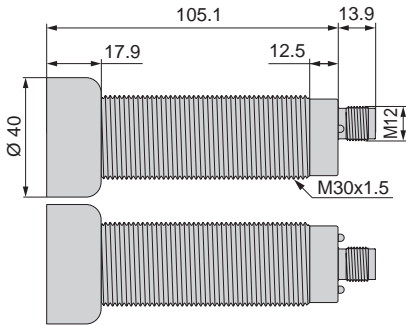

Connections

Connector wiring

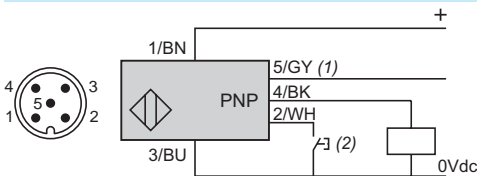

Pin number	Wire color	Digital output description	Analog output description	
			4-20 mA	0-10 V
1	BN: Brown	+12...24 V $\overline{\text{---}}$	+12...24 V $\overline{\text{---}}$	+14...24 V $\overline{\text{---}}$
2	WH: White	Input teach		
3	BU: Blue	0 V $\overline{\text{---}}$		
4	BK: Black	Output		
5	GY: Gray	Synchronization		

(1) Synchronization.

(2) External setting pushbutton or **XXZPB100** remote teach pushbutton (see page 69).

Wiring scheme (digital output NO or NC)

XXS30●●PM12

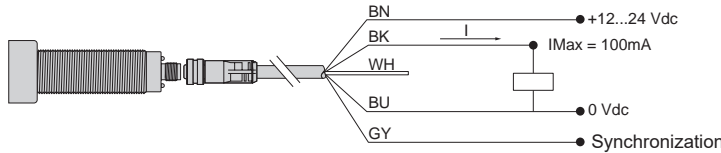

Wiring scheme (analog output 0-10V)

XX●30●●VM12

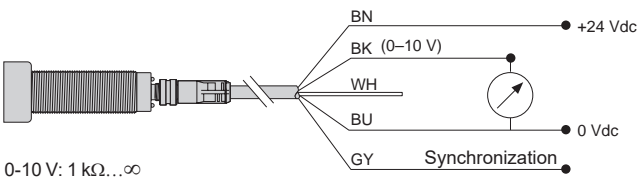

Wiring scheme (analog output 4-20 mA)

XX●30●●AM12

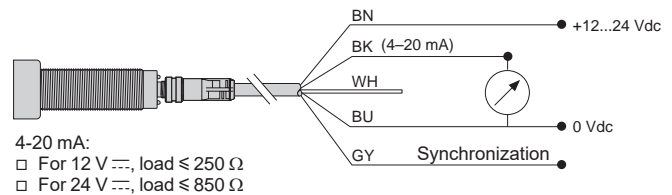
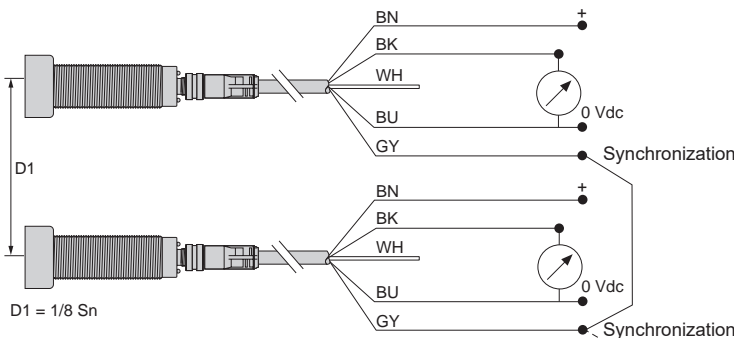

Diagram for the synchronization function (Side by side application)



NB: To enable synchronization between several sensors, all of the wires of pin no.5 (gray) must be electrically connected together. A maximum of 8 sensors can be synchronized. To enable "Multiplexer" function for the sensors, use the XX Configuration Software. Without synchronization or multiplexing, the sensors must be at least 50 cm away from each other in order to avoid mutual interference.

Ultrasonic sensors

XX range, General purpose

Cylindrical, plastic or metal, Ø 30 mm

Diffuse system, solid-state digital or analog output

Configurable by software

Dimensions (continued)

Fixing clamp XXZB130

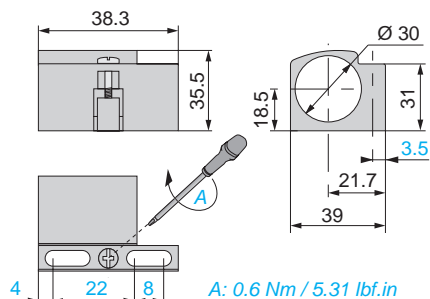

4

22 8

A: 0.6 Nm / 5.31 lbf.in

Teach pushbutton XXZPB100

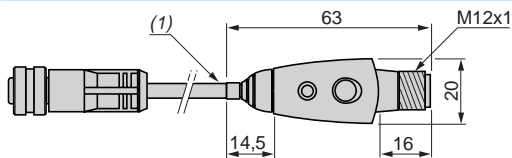

(1) Cable length: 152 mm

Curves

Detection curve with 100 x 100 mm square target

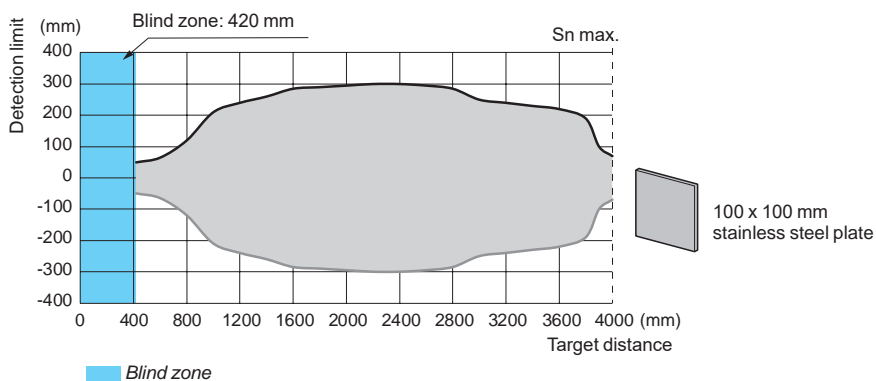

Blind zone

Detection curve with round bar

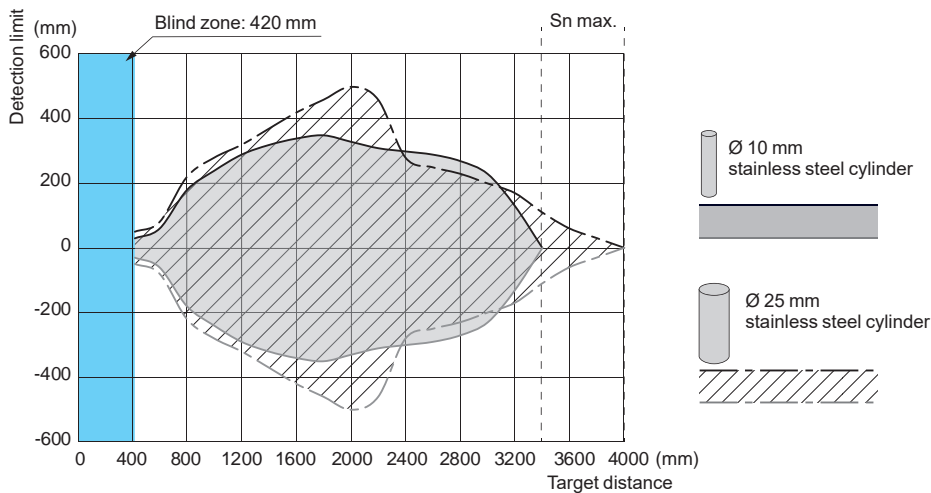

Blind zone

XX Configuration Software

Telemecanique Sensors is now offering a new solution for configuring ultrasonic XX range sensors. This software enables users to quickly find the optimal sensing solution for their applications. An interface unit connects the sensor to the PC via a USB connection.

> Easy configuration to unique applications

The configuration software has more than 20 parameters that can be modified to suit the machine application. The parameters can be saved in PDF format for quick, easy reference.

> Real-time sensor performance display

One of the best functions of the new software is the ability to troubleshoot and visualize the effects of the parameters on the configured sensor. The "echo display" function shows the exact position of any false echoes. The recording function can record the values of the echoes in an .xlsx or .xml file for extended periods of time.

> Quick duplication of programmed settings

Optimal parameters set on one sensor can be saved and loaded on other units of the same reference. This function reduces time and effort.

> The interface can be used to configure specific configurable models of XX ultrasonic sensors models (XXS●● & XXA●●).

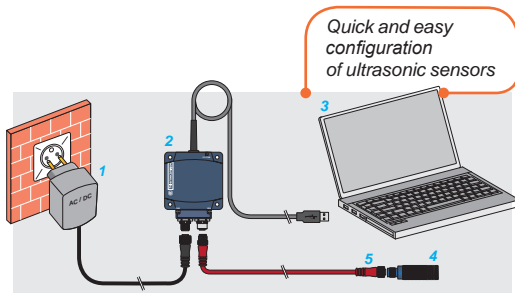

- 1: Power supply, provided with 4 adapters
- 2: Configuration interface **XXZBOX01**
- 3: XX Configuration Software, installed on a PC
- 4: Ultrasonic sensor **XXS●●** or **XXA●●**
- 5: M12-M12 cable

XX Configuration Software for ultrasonic sensors

> XX Configuration Software is available in English, French, German, Spanish, Italian, and Chinese. It can be installed using the setup file in the USB key provided with the configuration kit or downloaded directly from the website www.tesensors.com.

> Recommended PC performance:

- > Windows OS: 7 SP1 embedded standard(x86 & x64), 8.1 (x86 & x64), or 10 (x86 & x64)
- > Internet Explorer: 9.0 or higher
- > Disk space: 1 GB or higher
- > RAM memory: 2 GB or higher
- > Processor speed: 1 GHz or higher
- > Display resolution: 1360 x 768 or higher



Ultrasonic sensors configuration interface
XXZBOX01



Ultrasonic sensors configuration kit
XXZKIT01

Part number

Description	Reference	Weight kg
Ultrasonic sensors configuration interface		
Configuration interface	XXZBOX01	0.400
provided with:		
1 power supply (1)		
1 UK adapter		
1 SAA adapter		
1 US adapter		
1 EU adapter		
Ultrasonic sensors configuration kit		
Plastic case including:	XXZKIT01	1.200
1 configuration interface XXZBOX01		
1 power supply (1)		
1 UK adapter		
1 SAA adapter		
1 US adapter		
1 EU adapter		
1 cable of 1 m, with M12 connectors (5-pin male/female)		
1 USB Flash Drive/USB key, including: the setup file for XX Configuration Software, ReadMe file, instruction sheet, tutorial, and the XX range catalog.		

(1) Power supply: 24 V $\overline{-}$, 0.5A min., with M12 connector.

Configuration software presentation

Principle



- 1: Power supply, provided with 4 adapters
- 2: Configuration interface **XXZBOX01**
- 3: XX Configuration Software, installed on a PC
- 4: Ultrasonic sensor **XXS●●** or **XXA●●**

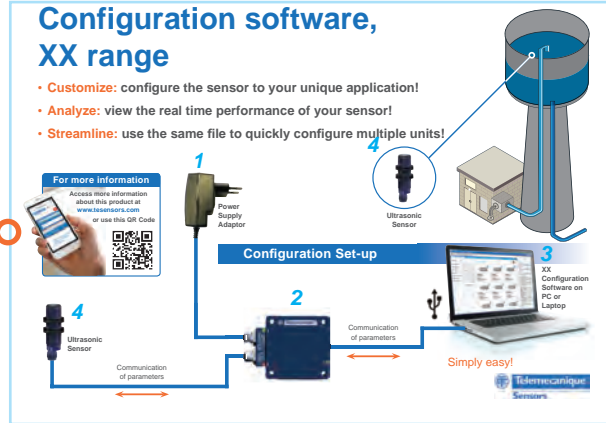

Setting examples

Sensor selection

- > This page is used to manually select or auto-download the XX reference sensor to be configured. Once a reference has been selected, the user can start the configuration process.
- > There are 4 methods of selection. The **Reset search** button can reinitialize the search, regardless of the method used.
 - 1: Direct selection from the full reference list
 - 2: Selection through reference
 - 3: Manual search using criteria
 - 4: Automatic sensor detection

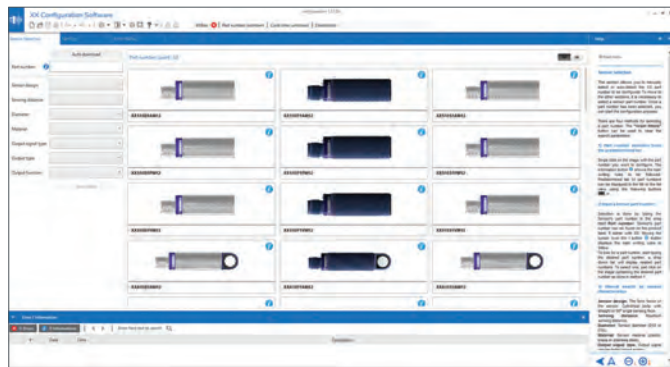

Detection settings

- > This tab is used to configure the sensor detection settings.

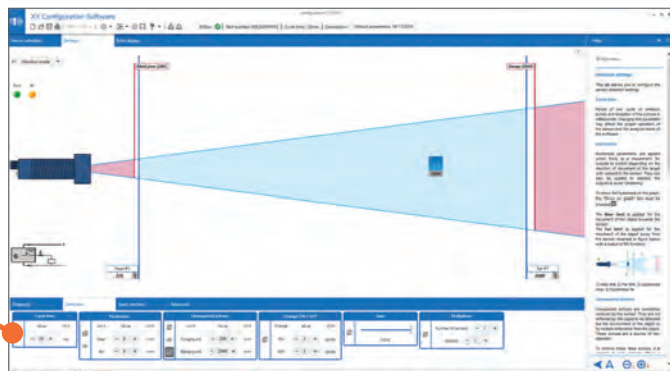
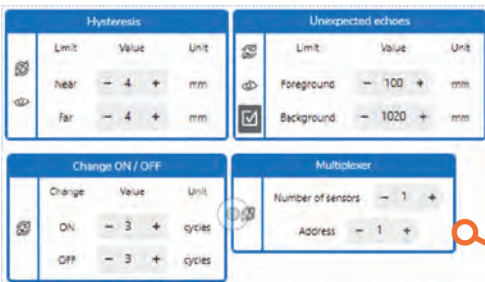

Output settings

- > This page enables the configuration of sensor outputs. If the sensor has several outputs, they may be configured separately, unless specified otherwise.

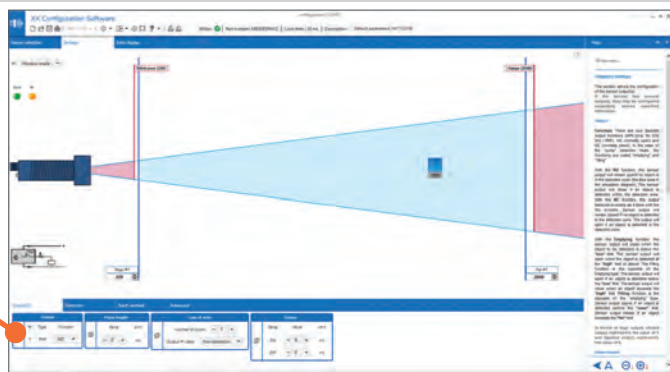
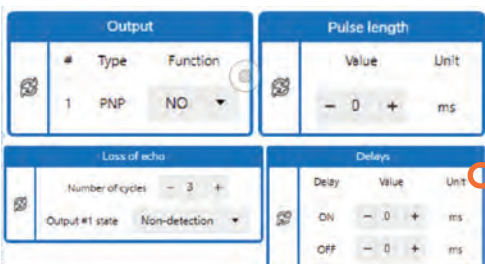

Configuration software presentation (continued)

Setting examples (continued)

Teach method settings

- > This tab allows the configuration of the pushbutton for manual teaching. Depending on the sensor reference, the teach button is either integrated in the sensor or available through the teach pushbutton **XXZPB100** (see page 69).

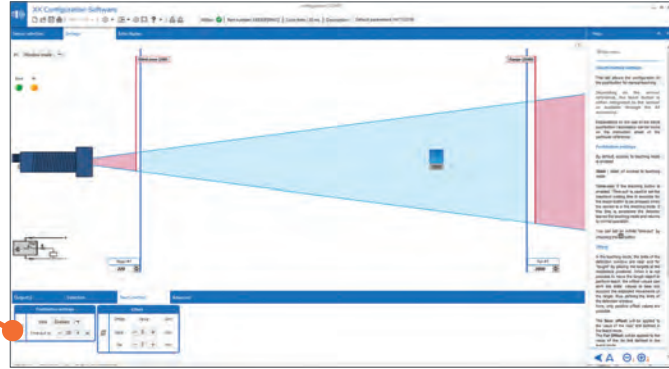

Echo display mode

- > With the “echo display” mode, the user can visualize several echoes received by the sensor in the same cycle.
- > The first valid echo is shown in blue and the others in gray. The blue echo is what the sensor considers as the detected object.
- > It is also possible to record the data over extended periods of time using the “record” function.

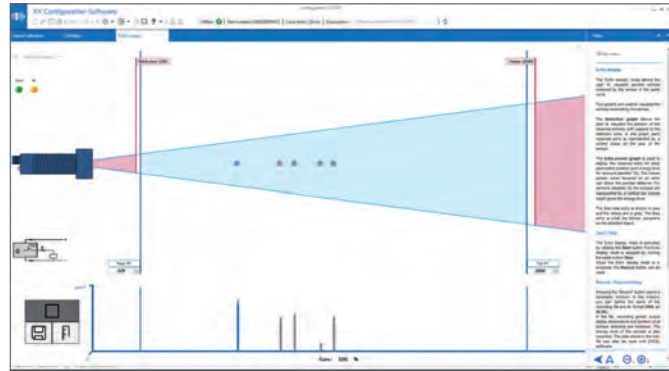

Measure mode

- > The “measure” button opens a pop-up window giving a real-time numerical display of the position of the object in mm or inches.

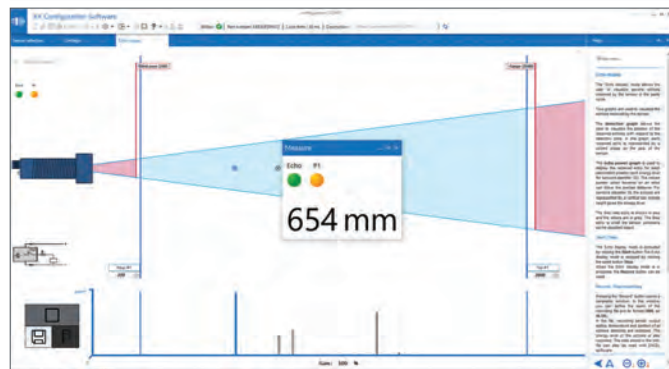

Characteristics

Supply characteristics

Rated supply voltage (Ue) with protection against reverse polarity	V	24 V $\overline{\text{---}}$
Voltage limits	V	14...30 V $\overline{\text{---}}$ (ripple: 10% max)
Consumption	W	4 (consumption excluding sensor)

LED indicators

LED indicators	Power supply	Green LED
	PC communication	Orange LED
	Error	Red LED

Communication

Data communication baud rate	bps	19,200
------------------------------	-----	--------

Connection

Maximum cabling distance between sensor and interface	m	3
Electrical connection to sensor		M12 female connector
Connection to PC or laptop		0.5 m USB cable , A type connector

Environment characteristics

Compliance to regulations		CE
Degree of protection	Conforming to IEC 60529	IP 40
Storage temperature	°C	-20...+45
Operating temperature	°C	0...+45
Relative humidity		< 95%, without condensation

Dimensions

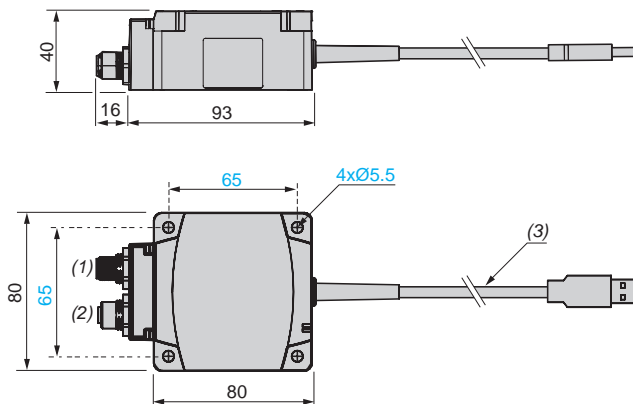

- (1) Male M12 connector, 5-pin: power supply
(2) Female M12 connector, 5-pin: sensor
(3) Cable length: 0.5 m (USB cable A type connector): PC

Connections

Interface connector for power supply adapter (M12 male)



Pin number	Wire color	Description
1	BN: Brown	+14...30 V $\overline{\text{---}}$
2	WH: White	Output 2 (4) (5)
3	BU: Blue	0 V $\overline{\text{---}}$
4	BK: Black	Output 1 (4)
5	–	Not used (6)

Interface connector for sensor (M12 female)

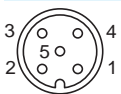

Pin number	Description
1	Power out to sensor
2	Software communication
3	0 V $\overline{\text{---}}$
4	Software communication
5	Not used (6)

(4) Output is only active during the "echo display" mode and "measure" mode.

(5) Output 2 is not available on all sensors.

(6) The 5th pins of the M12 male and M12 female connectors are electrically connected to one another.

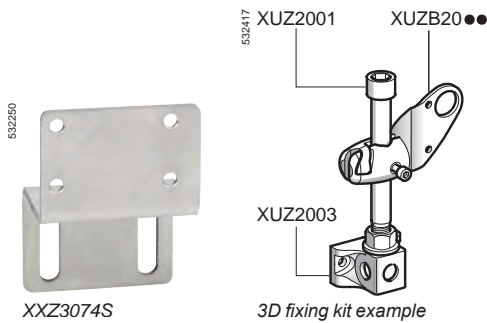
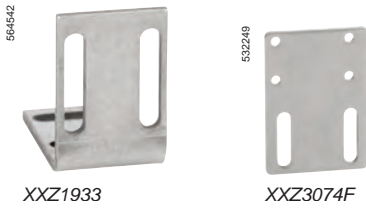

References of accessories

Cabling accessories

Connectors	For use with sensor	Type of connection		Reference	Weight kg
M8 3-pin	Ø 12	IDC (Insulation Displacement Connector)	Straight	XZCC8FDM30V	0.010
	XX512A2		Elbowed	XZCC8FCM30V	0.010
M8 4-pin	XX512A1		Straight	XZCC8FDM40V	0.010
	XX12A8		Elbowed	XZCC8FCM40V	0.010
M12	Ø 18, Ø 30	Screw terminals, metal clamping ring	Straight	XZCC12FDM40B	0.020
			Elbowed	XZCC12FCM40B	0.020
		Screw terminals, plastic clamping ring	Straight	XZCC12FDP40B	0.020
			Elbowed	XZCC12FCP40B	0.020

Pre-wired connectors	For use with sensor	Type	Cable length m	Reference	Weight kg
M8 3-pin	Ø 12 XX512A2	Straight	2	XZCP0166L2 (1)	0.080
		Elbowed	2	XZCP0266L2 (1)	0.080
M12	Ø 18, Ø 30	Straight	2	XZCP1141L2 (1)	0.090
		Elbowed	2	XZCP1241L2 (1)	0.090

Fixing accessories

Description	For use with sensor	Reference	Weight kg
Fixing clamps	Ø 12	XSZB112	0.006
	Ø 18	XSZB118	0.010
	Ø 30	XSZB130	0.020
Fixing clamps (mounting on 35 mm rail)	XXD	XSZBD10	0.065
90° fixing bracket	Ø 12	XXZ12	0.025
	Ø 18	XUZA118	0.038
	Ø 30	XXZ30	0.115
	XX7F	XXZ1933	0.025
Flat mounting plate	XX7K	XXZ3074F	0.025
Cranked mounting plate	XX7K	XXZ3074S	0.075
3D fixing kit (2)	M12 rod Ø 12, Ø 18 and Ø 30	XUZ2001	0.050
	Support for M12 rod Ø 12, Ø 18 and Ø 30	XUZ2003	0.160
Ball-joint mounted fixing bracket	Ø 12	XUZB2012	0.175
	Ø 18	XUZB2003	0.175
	Ø 30	XUZB2030	0.160

(1) For a 5 m long cable replace L2 by L5, for a 10 m long cable replace L2 by L10.

(2) To obtain a 3D fixing kit, order:

rod support **XUZ2003**, M12 rod **XUZ2001** and ball-joint mounted fixing bracket **XUZB20**.

Dimensions

Fixing accessories

XUZA118

90° fixing bracket (Ø 18)

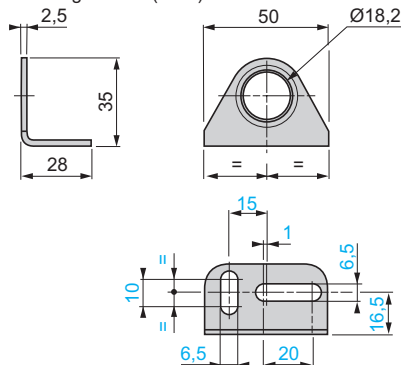

XXZ12, XXZ30

90° fixing bracket (Ø 12 and Ø 30)

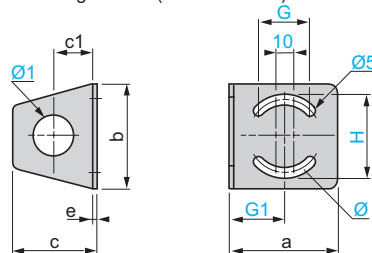

XXZ	a	b	c	c1	e	H	G	G1	Ø	Ø1
12	35	40	33	18	2	31	18	18	25	13
30	67	65	52	25	3	51	35	33	50	31

Dimensions (continued)

Fixing accessories (continued)

XSZB112, XSZB118

Fixing clamps (Ø 12, Ø 18 and Ø 30)

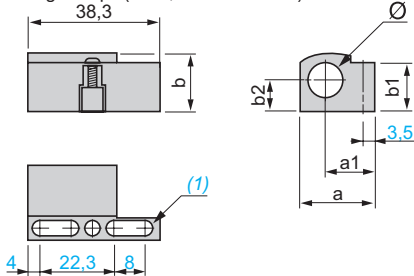

XSZ	a	a1	b	b1	b2	Ø
B112	21.9	14.5	16	15.5	8.5	12
B118	26	15.7	22.3	20.1	11.5	18
B130	39	21.7	35.5	31	18.5	30

(1) 2 elongated holes Ø 4 x 8.

XXZ3074F

Flat mounting plate (XX•K•)

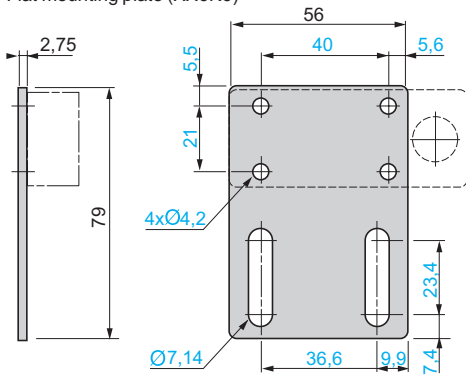

XXZ1933

90° fixing bracket (XX•F•)

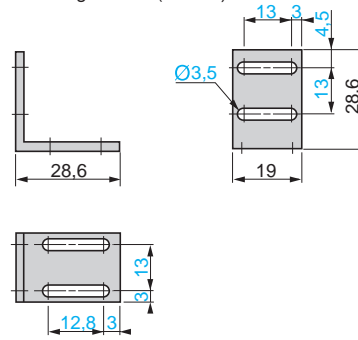

XXZ3074S

Cranked mounting plate (XX•K•)

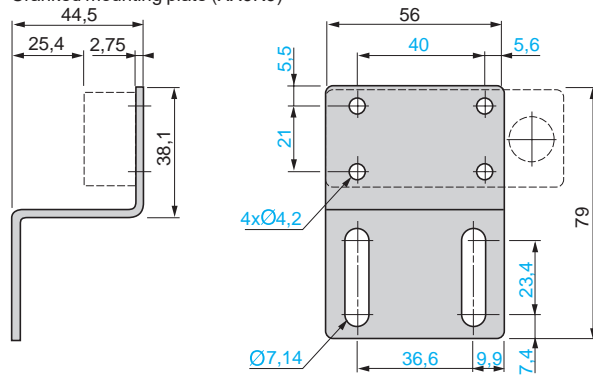

XUZ2001

M12 rod

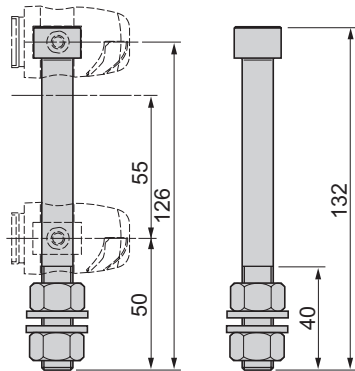

XUZ2003

Support for M12 rod

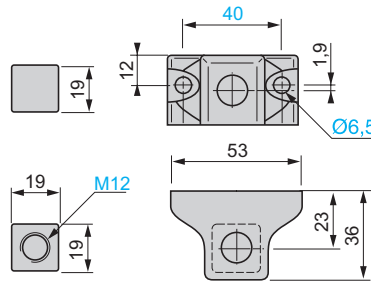

XSZBD10

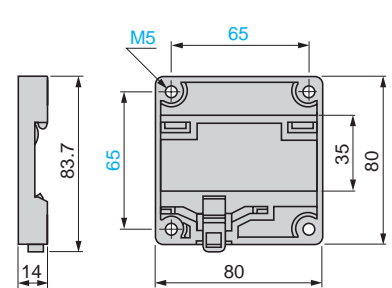

XUZB2012

Ball-joint mounted fixing bracket (Ø 12)

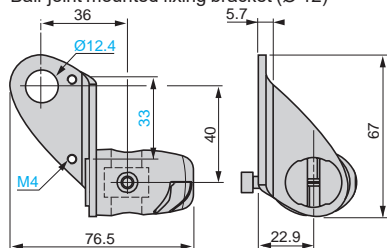

XUZB2003

Ball-joint mounted fixing bracket (Ø 18)

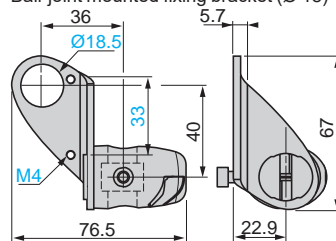

XUZB2030

Ball-joint mounted fixing bracket (Ø 30)

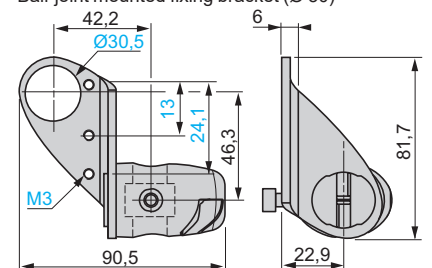

X							
XSZB112	74	XX930A2A2230M12	37	XXS18S1AM12	31	XXZPB100	27
XSZB118	74	XX930A2A2M12	37	XXS18S1PM12	31		31
XSZB130	74	XX930A3A1M12	37	XXS18S1VM12	31		41
XSZBD10	74	XX930A3A2M12	37	XXS30B1AM12	52		44
XUZ2001	74	XX930S1A1M12	37	XXS30B1PM12	51		45
XUZ2003	74	XX930S1A2M12	37	XXS30B1VM12	52	XZCC12FCM40B	74
XUZA118	74	XX9D1A1C2M12	45	XXS30B2AM12	52	XZCC12FCM50B	32
XUZB2003	74	XX9D1A1F1M12	45	XXS30B2PM12	51	XZCC12FCP40B	74
XUZB2012	74	XX9V1A1C2M12	45	XXS30B2VM12	52	XZCC12FDM40B	74
XUZB2030	74	XX9V1A1F1M12	45	XXS30B4AM12	52	XZCC12FDM50B	32
XX218A3NFM12	41	XX9V3A1C2M12	37	XXS30B4PM12	51		53
XX218A3NHM12	41	XX9V3A1F1M12	37	XXS30B4VM12	52	XZCC12FDP40B	74
XX218A3PFM12	41	XXA18B1AM12	31	XXS30P1AM12	51	XZCC8FCM30V	74
XX218A3PHM12	41	XXA18B1PM12	31	XXS30P1PM12	51	XZCC8FCM40V	74
XX230A10PA00M12	41	XXA18B1VM12	31	XXS30P1VM12	51	XZCC8FDM30V	74
XX230A11PA00M12	41	XXA18P1AM12	31	XXS30P2AM12	51	XZCC8FDM40V	74
XX230A12NA00M12	41	XXA18P1PM12	31	XXS30P2PM12	51	XZCP0166L2	74
XX230A12PA00M12	41	XXA18P1VM12	31	XXS30P2VM12	51	XZCP0266L2	74
XX230A20PA00M12	41	XXA18S1AM12	31	XXS30P4AM12	51	XZCP1141L10	32
XX230A21PA00M12	41	XXA18S1PM12	31	XXS30P4PM12	51		53
XX230A22NA00M12	41	XXA18S1VM12	31	XXS30P4VM12	51	XZCP1141L2	32
XX230A22PA00M12	41	XXA30B1AM12	52	XXS30S1AM12	52		32
XX512A1KAM8	22	XXA30B1PM12	51	XXS30S1PM12	51		53
XX512A2NAM8	22	XXA30B1VM12	52	XXS30S1VM12	52	XZCP1141L5	32
XX512A2PAM8	22	XXA30B2AM12	52	XXS30S2AM12	52		53
XX518A1KAM12	22	XXA30B2PM12	51	XXS30S2PM12	51	XZCP1241L10	32
XX518A3NAL2	27	XXA30B2VM12	52	XXS30S2VM12	52		53
XX518A3NAM12	27	XXA30P1AM12	51	XXS30S4AM12	52	XZCP1241L2	32
XX518A3PAL2	27	XXA30P1PM12	51	XXS30S4PM12	51		53
XX518A3PAM12	27	XXA30P1VM12	51	XXS30S4VM12	52	XZCPV11V12L10	32
XX630A1KAM12	37	XXA30P2AM12	51	XXT12A8M8	22		53
XX630A1NCM12	37	XXA30P2PM12	51	XXT18A3M12	27	XZCPV11V12L2	32
XX630A1PCM12	37	XXA30P2VM12	51	XXTF1A8M12L	44		53
XX630A2NCM12	37	XXA30S1AM12	52	XXTK1A3M12	27	XZCPV11V12L5	32
XX630A2PCM12	37	XXA30S1PM12	51		44		53
XX630A3NCM12	37	XXA30S1VM12	52	XXTK1A4M12	27	XZCPV12V12L10	32
XX630A3PCM12	37	XXA30S2AM12	52		44	XZCPV12V12L2	32
XX630S1NCM12	37	XXA30S2PM12	51	XXV18B1NAL10	22		53
XX630S1PCM12	37	XXA30S2VM12	52	XXV18B1NAL2	22	XZCPV12V12L5	32
XX630S1PCM12	37	XXBD1A1PAM12	44	XXV18B1NAL5	22		53
XX6V3A1NAM12	37	XXBV1A1PAM12	44	XXV18B1NAM12	22	XZCPV12V12L2	32
XX6V3A1PAM12	37	XXBV3A1PAM12	37	XXV18B1NBL10	22		53
XX7F1A2NAL01M12	22	XXR12A8KAM8	22	XXV18B1NBL2	22	XZCPV12V12L5	32
	44	XXR12A8KBM8	22	XXV18B1NBL5	22		53
XX7F1A2PAL01M12	22	XXR18A3KAM12	27	XXV18B1NBM12	22	XZCPV12V12L10	32
	44	XXR18A3KBM12	27	XXV18B1PAM12	22	XZCPV12V12L2	32
XX7K1A2NAM12	22	XXR18A4KAM12	27	XXV18B1PAL10	22		53
	44	XXR18A4KAM12	27	XXV18B1PAL2	22	XZCPV12V12L5	32
XX7K1A2PAM12	22	XXR18A4KBM12	27	XXV18B1PAL5	22		53
	44	XXRF1A8KAM12L	44	XXV18B1PAM12	22	XZCPV12V12L2	32
XX7V1A1NAM12	27	XXRF1A8KBM12L	44	XXV18B1PBL10	22		53
	44	XXRK1A3KAM12	27	XXV18B1PBL2	22	XZCPV12V12L5	32
XX7V1A1PAM12	27		44	XXV18B1PBL5	22		53
	44	XXRK1A3KBM12	27	XXV18B1PBM12	22		53
XX8D1A1NAM12	27		44	XXZ12	74		32
	44	XXRK1A4KAM12	27	XXZ1933	74		53
XX8D1A1PAM12	27		44	XXZ30	74		53
	44	XXRK1A4KBM12	27	XXZ3074F	74		56
XX918A3C2M12	27		44	XXZ3074S	74		56
XX918A3F1M12	27	XXS18B1AM12	31	XXZB118	32		56
XX930A1A1230M12	37	XXS18B1PM12	31	XXZB130	53		56
XX930A1A1M12	37	XXS18B1VM12	31		53		56
XX930A1A2230M12	37	XXS18P1AM12	31	XXZBOX01	56		56
XX930A1A2M12	37	XXS18P1PM12	31	XXZKIT01	56		56
XX930A2A1230M12	37	XXS18P1VM12	31				
XX930A2A1M12	37						

Schneider Electric Industries SAS

Head Office
35, rue Joseph Monier
F-92500 Rueil-Malmaison
France

www.tesensors.com

The information provided in this documentation contains general descriptions and/or technical characteristics of the performance of the products contained herein. This documentation is not intended as a substitute for and is not to be used for determining suitability or reliability of these products for specific user applications. It is the duty of any such user or integrator to perform the appropriate and complete risk analysis, evaluation and testing of the products with respect to the relevant specific application or use thereof. Neither Schneider Electric nor any of its affiliates or subsidiaries shall be responsible or liable for misuse of the information contained herein.

Design: Schneider Electric
Photos: Schneider Electric

October 2019 - V1.0

DIA4ED2191101EN